

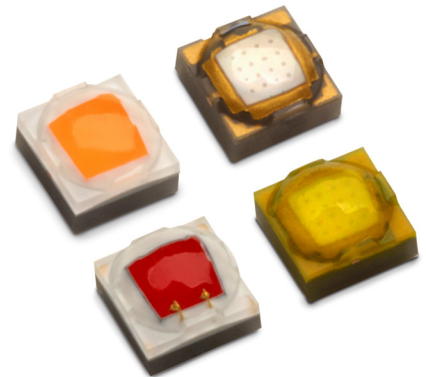

LUXEON C Color Line

Multiple colors, a single focal length

The LUXEON C Line is an optically advanced portfolio of Color and White LEDs. Designed for flawless color mixing, LUXEON C Color Line has one focal length for all colors, which provides consistent radiation patterns from secondary optics and maximizes optical efficiency. With low dome design, it keeps effective source size small while still improving light extraction. Designed for smooth color mixing and maximum punch, LUXEON C Color Line is the optimal LED solution for architecture, emergency vehicle lighting and horticulture lighting applications.



FEATURES AND BENEFITS

One focal length allows flawless color mixing, maximum optical efficiency and removes halos

Low dome design eliminates trade-offs between flux and source size

Hot tested—removes guesswork for designers

Industry's lowest thermal resistance means greater light output and lower heatsink costs

Small symmetrical 2x2mm² package enables dense packing and limits the impact of rotation during reflow

PRIMARY APPLICATIONS

Architectural

Lamps

- Color Tunable

Specialty Lighting

- Emergency Vehicle

- Horticulture

Table of Contents

General Product Information	2
Product Test Conditions	2
Part Number Nomenclature	2
Lumen Maintenance	2
Environmental Compliance	2
Performance Characteristics	3
Product Selection Guide	3
Optical Characteristics	3
Electrical and Thermal Characteristics	4
Absolute Maximum Ratings	4
Characteristic Curves	5
Spectral Power Distribution Characteristics	5
Light Output Characteristics	6
Forward Current Characteristics	11
Radiation Pattern Characteristics	13
Product Bin and Labeling Definitions	15
Decoding Product Bin Labeling	15
Luminous Flux Bins	16
Radiometric Power Bins	16
Color Bin Definition	17
Dominant Wavelength Bins	18
Peak Wavelength Bins	18
Forward Voltage Bins	19
Mechanical Dimensions	20
Reflow Soldering Guidelines	21
JEDEC Moisture Sensitivity	21
Solder Pad Design	22
Packaging Information	22
Pocket Tape Dimensions	22
Reel Dimensions	23

General Product Information

Product Test Conditions

LUXEON C LEDs are tested and binned with a DC drive current of 350mA at a junction temperature, T_j , of 85°C.

Part Number Nomenclature

Part numbers for LUXEON C Colors follow the convention below:

L 1 C 1 – **A A A** 1 0 0 0 0 0 0 0 0 0

Where:

A A A – designates color (RED=Red, RNG=Red-Orange, PCA=PC Amber, GRN=Green, CYN=Cyan, BLU=Blue, RYL=Royal Blue)

Therefore, the following part number is used for a LUXEON C Red:

L 1 C 1 – **R E D** 1 0 0 0 0 0 0 0 0 0

Part numbers for LUXEON C White follow the convention below:

L 1 C 1 – **A A B B** 0 0 0 0 0 0 0 0 0 0

Where:

A A – designates nominal CCT (40=4000K, 57=5700K)

B B – designates minimum CRI (70=70CRI)

Therefore, the following part number is used for LUXEON C White at 4000K 70CRI:

L 1 C 1 – **4 0 7 0** 0 0 0 0 0 0 0 0 0 0

Lumen Maintenance

Please contact your local Sales Representative or Lumileds Technical Solutions Manager for more information about the long-term performance of this product.

Environmental Compliance

Lumileds LLC is committed to providing environmentally friendly products to the solid-state lighting market. LUXEON C is compliant to the European Union directives on the restriction of hazardous substances in electronic equipment, namely the RoHS Directive 2011/65/EU and REACH Regulation (EC) 1907/2006. Lumileds LLC will not intentionally add the following restricted materials to its products: lead, mercury, cadmium, hexavalent chromium, polybrominated biphenyls (PBB) or polybrominated diphenyl ethers (PBDE).

Performance Characteristics

Product Selection Guide

Table 1a. Product performance of LUXEON C Colors at 350mA, T_j=85°C.

COLOR	DOMINANT OR PEAK WAVELENGTH ^[1] (nm)		LUMINOUS FLUX (lm) OR RADIOMETRIC POWER (mW) ^[2]		PART NUMBER
	MINIMUM	MAXIMUM	MINIMUM	TYPICAL	
Red	624	634	35	39	L1C1-RED1000000000
Red-Orange	614	624	45	52	L1C1-RNG1000000000
PC Amber	-	-	80	94	L1C1-PCA1000000000
Green	520	540	90	97	L1C1-GRN1000000000
Cyan	490	510	65	72	L1C1-CYN1000000000
Blue	465	485	25	37	L1C1-BLU1000000000
Royal Blue	440	460	480	532	L1C1-RYL1000000000

Notes for Table 1a:

- Lumileds maintains a tolerance of ±6.5% on luminous flux measurements. PC Amber is binned by chromaticity coordinates. Royal Blue is binned by peak wavelength. All other colors are binned by dominant wavelength.
- Royal Blue is binned by radiometric power. All other colors are binned by luminous flux.

Table 1b. Product performance of LUXEON C White at 350mA, T_j=85°C.

NOMINAL CCT	MINIMUM CRI	LUMINOUS FLUX (lm)		TYPICAL LUMINOUS EFFICACY (lm/W)	PART NUMBER
		MINIMUM	TYPICAL		
4000K	70	100	116	121	L1C1-4070000000000
5700K	70	100	118	124	L1C1-5770000000000

Notes for Table 1b:

- Lumileds maintains a tolerance of ±2 on CRI and ±6.5% on luminous flux measurements.

Optical Characteristics

Table 2a. Optical characteristics for LUXEON C Colors at 350mA, T_j=85°C.

PART NUMBER	TYPICAL SPECTRAL HALF-WIDTH ^[1] (nm)	TYPICAL TOTAL INCLUDED ANGLE ^[2]	TYPICAL TEMPERATURE COEFFICIENT OF DOMINANT OR PEAK WAVELENGTH (nm/°C)	TYPICAL VIEWING ANGLE ^[3]
L1C1-RED1000000000	20	146°	0.06	150°
L1C1-RNG1000000000	20	146°	0.06	150°
L1C1-PCA1000000000	80	146°	-0.01	150°
L1C1-GRN1000000000	30	146°	0.04	150°
L1C1-CYN1000000000	30	146°	0.03	150°
L1C1-BLU1000000000	20	146°	0.03	150°
L1C1-RYL1000000000	20	146°	0.03	150°

Notes for Table 2a:

- Spectral half-width is the spectral bandwidth at 50% of the peak intensity.
- Total angle at which 90% of total luminous flux is captured.
- Viewing angle is the off axis angle from the LED centerline where the luminous intensity is ½ of the peak value.

Table 2b. Optical characteristics for LUXEON C White at 350mA, T_j=85°C.

PART NUMBER	TYPICAL TOTAL INCLUDED ANGLE [2]	TYPICAL VIEWING ANGLE [3]
L1C1-xx7000000000	146°	150°

Notes for Table 2b:

1. Spectral half-width is the spectral bandwidth at 50% of the peak intensity.
2. Total angle at which 90% of total luminous flux is captured.
3. Viewing angle is the off axis angle from the LED centerline where the luminous intensity is ½ of the peak value.

Electrical and Thermal Characteristics

Table 3. Electrical and thermal characteristics for LUXEON C Colors at 350mA, T_j=85°C.

PART NUMBER	FORWARD VOLTAGE (V) [1]			TYPICAL TEMPERATURE COEFFICIENT OF FORWARD VOLTAGE (mV/°C) [2]	TYPICAL THERMAL RESISTANCE — JUNCTION TO SOLDER PAD (°C/W)
	MINIMUM	TYPICAL	MAXIMUM		
L1C1-RED1000000000	1.75	2.00	2.50	-1.6	2.8
L1C1-RNG1000000000	1.75	2.05	2.50	-1.6	2.8
L1C1-PCA1000000000	2.50	2.75	3.50	-1.7	3.0
L1C1-GRN1000000000	2.50	2.55	3.50	-2.4	3.5
L1C1-CYN1000000000	2.50	2.60	3.50	-2.4	3.5
L1C1-BLU1000000000	2.50	2.90	3.50	-2.6	3.5
L1C1-RYL1000000000	2.50	2.75	3.50	-1.7	2.8
L1C1-xxx000000000	2.50	2.75	3.50	-1.7	2.8

Notes for Table 3:

1. Lumileds maintains a tolerance of ±0.06V on forward voltage measurements.
2. Measured between 25°C and 85°C.

Absolute Maximum Ratings

Table 4. Absolute maximum ratings for LUXEON C Color Line.

PARAMETER	GREEN, CYAN, BLUE AND ROYAL BLUE	RED, RED-ORANGE AND PC AMBER	WHITE
DC Forward Current [1,2]	1050mA	1050mA	1225mA
Peak Pulsed Forward Current [1,3]	1050mA	1050mA	1225mA
LED Junction Temperature [1] (DC & Pulse)	135°C	120°C	135°C
ESD Sensitivity (ANSI/ESDA/JEDEC JS-001-2012)	Class 3A	Class 3A	Class 3A
LED Storage Temperature	-40°C to 135°C		
Soldering Temperature	JEDEC 020c 260°C		
Allowable Reflow Cycles	3		
Reverse Voltage (V _{reverse})	LUXEON C LEDs are not designed to be driven in reverse bias		

Notes for Table 4:

1. Proper current derating must be observed to maintain the junction temperature below the maximum allowable junction temperature.
2. Residual periodic variations due to power conversion from alternating current (AC) to direct current (DC), also called "ripple," are acceptable if the following conditions are met:
 - The frequency of the ripple current is 100Hz or higher
 - The average current for each cycle does not exceed the maximum allowable DC forward current
 - The maximum amplitude of the ripple does not exceed the maximum peak pulsed forward current
3. At 10% duty cycle with pulse width of 10ms.

Characteristic Curves

Spectral Power Distribution Characteristics

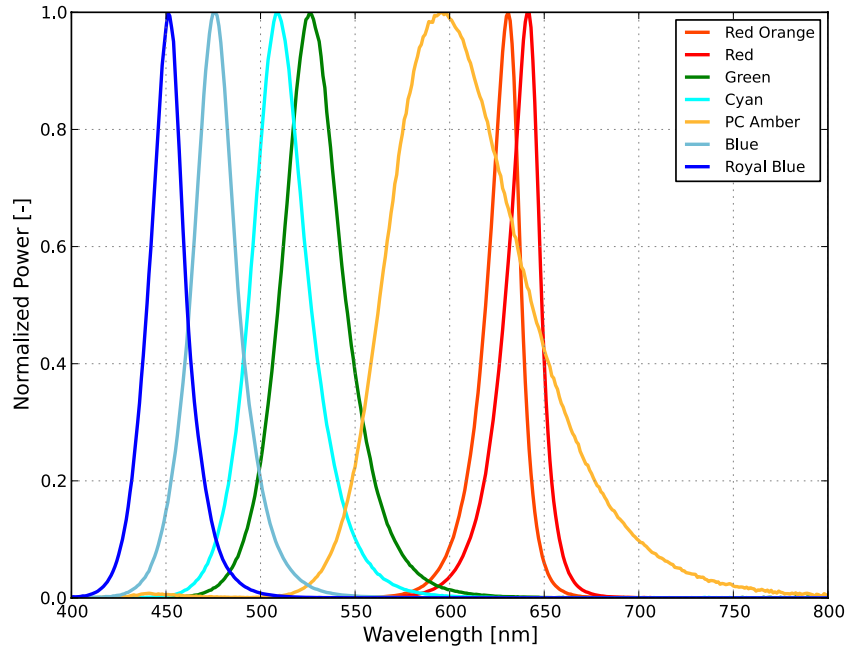

Figure 1: Typical normalized power vs. wavelength for LUXEON C Colors at 350mA, $T_j=85^\circ\text{C}$.

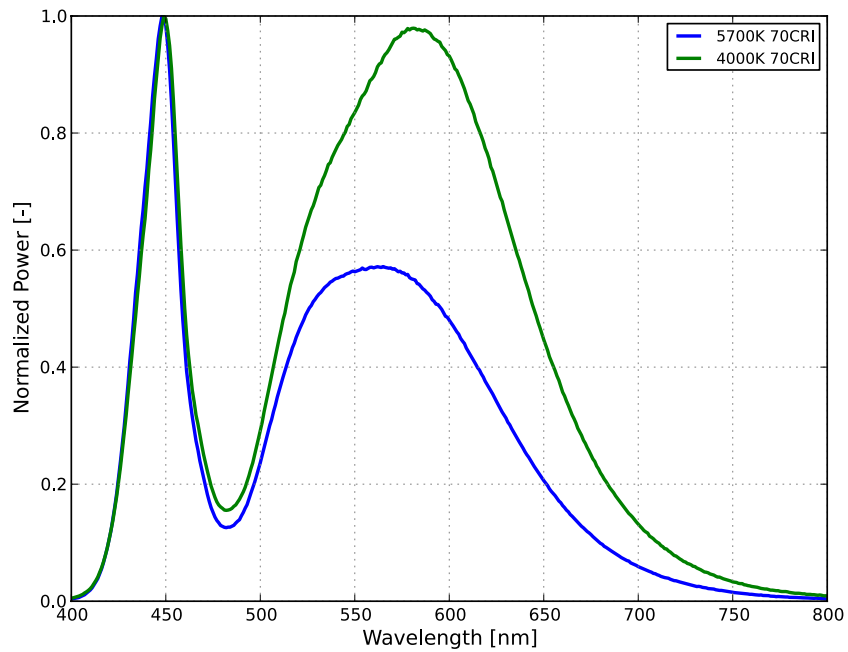

Figure 2: Typical normalized power vs. wavelength for LUXEON C White at 350mA, $T_j=85^\circ\text{C}$.

Light Output Characteristics

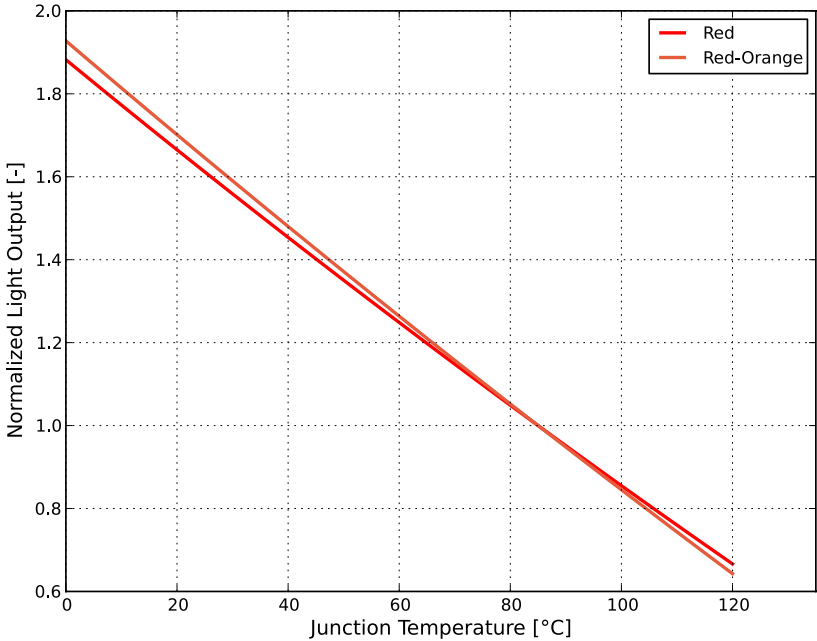

Figure 3a: Typical normalized light output vs. junction temperature for LUXEON C Red and Red-Orange at 350mA.

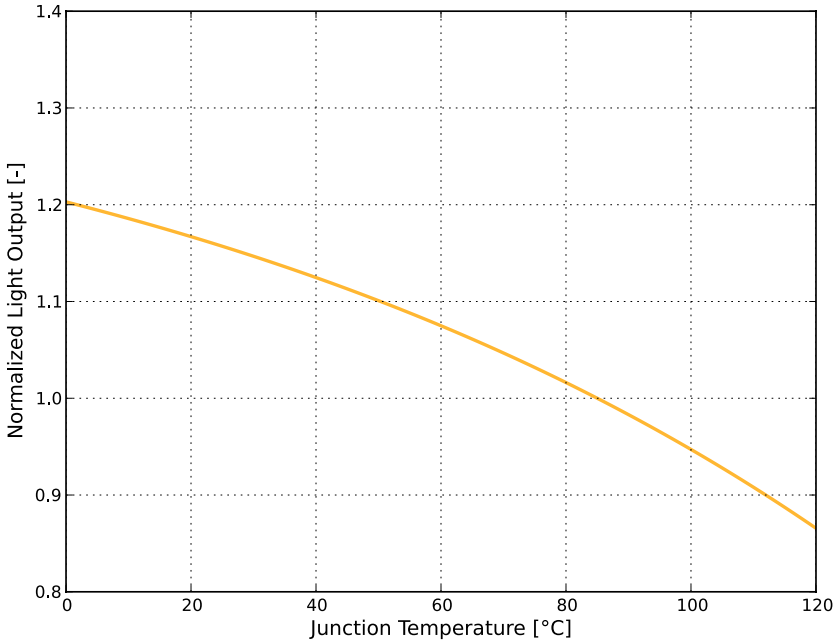

Figure 3b: Typical normalized light output vs. junction temperature for LUXEON C PC Amber at 350mA.

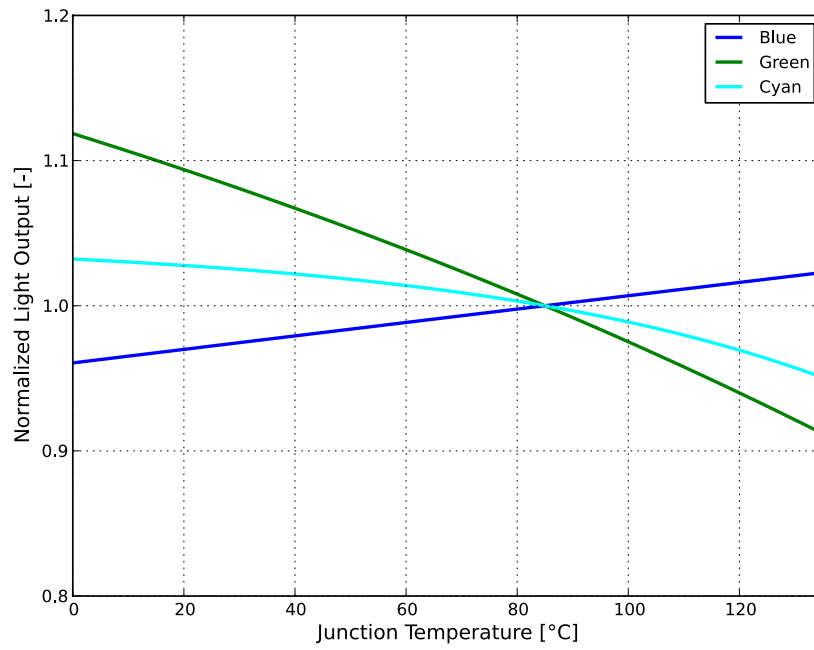

Figure 3c: Typical normalized light output vs. junction temperature for LUXEON C Cyan, Green and Blue at 350mA.

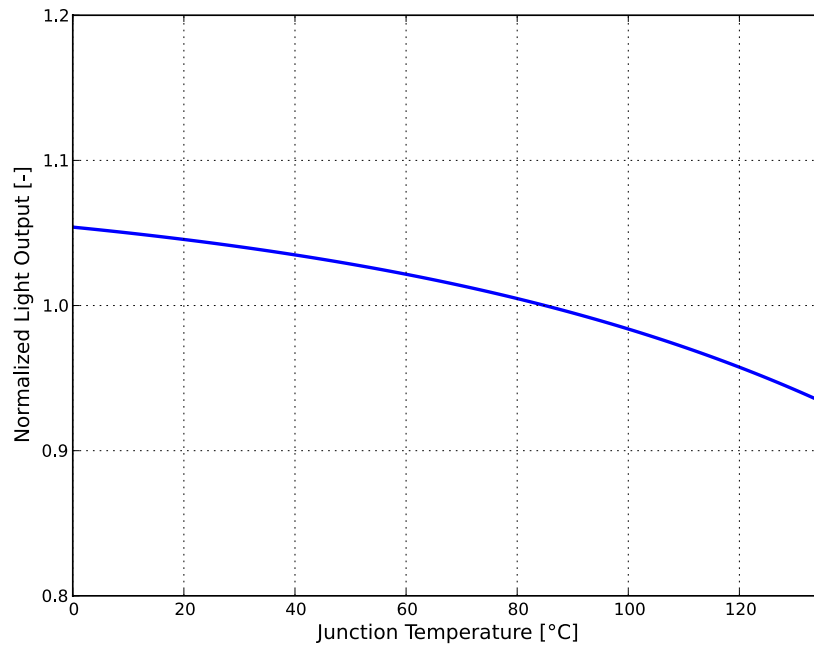

Figure 3d: Typical normalized light output vs. junction temperature for LUXEON C Royal Blue at 350mA.

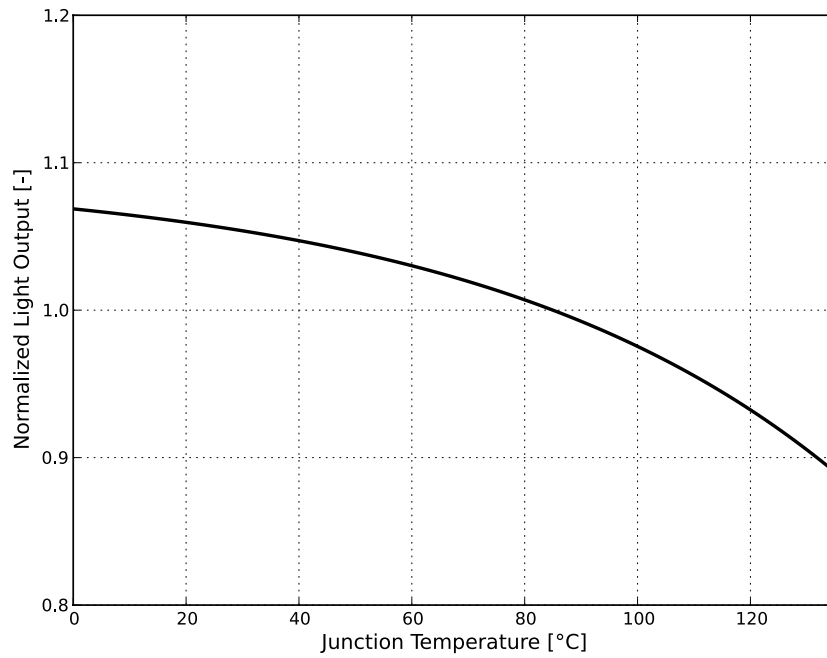

Figure 3e: Typical normalized light output vs. junction temperature for LUXEON C White at 350mA.

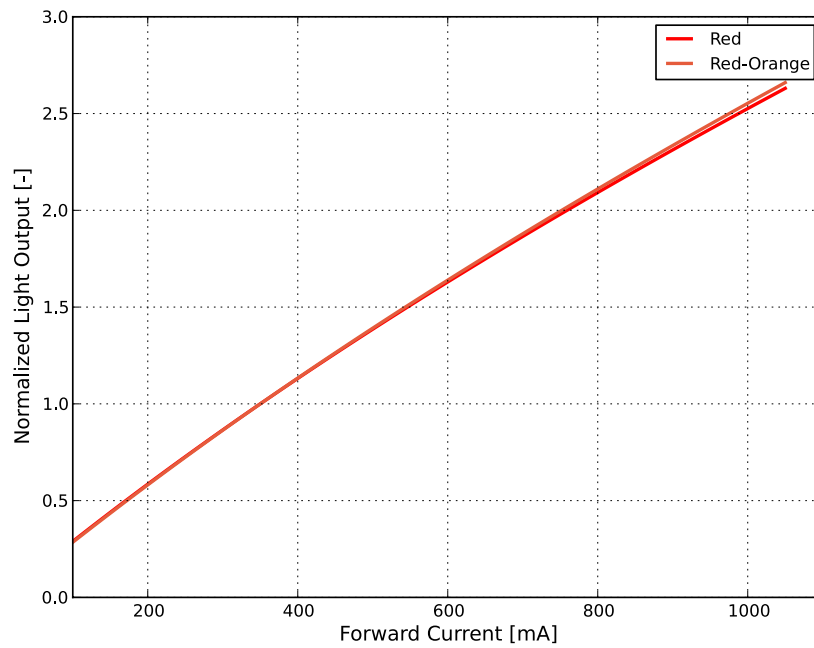

Figure 4a: Typical normalized light output vs. forward current for LUXEON C Red and Red-Orange at $T_j=85^{\circ}\text{C}$.

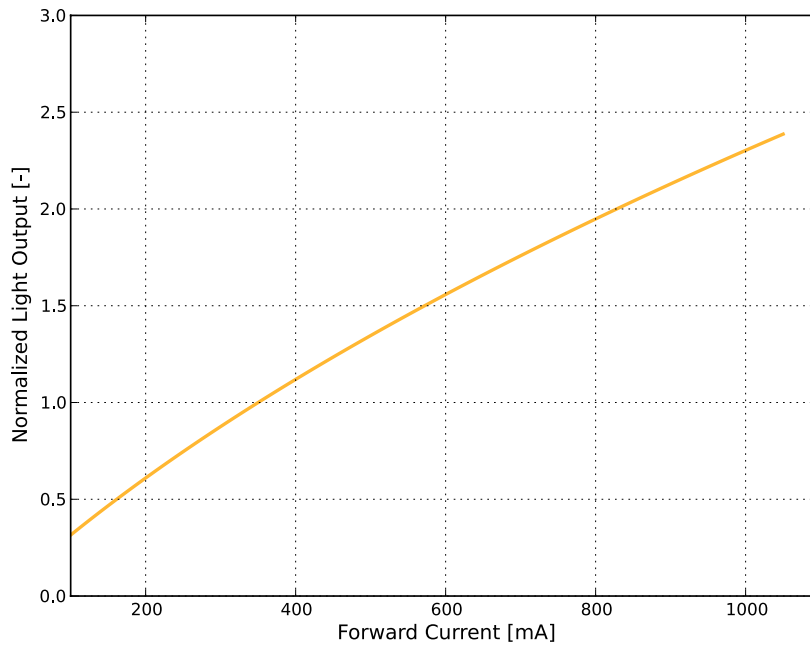

Figure 4b: Typical normalized light output vs. forward current for LUXEON C PC Amber at $T_j=85^\circ\text{C}$.

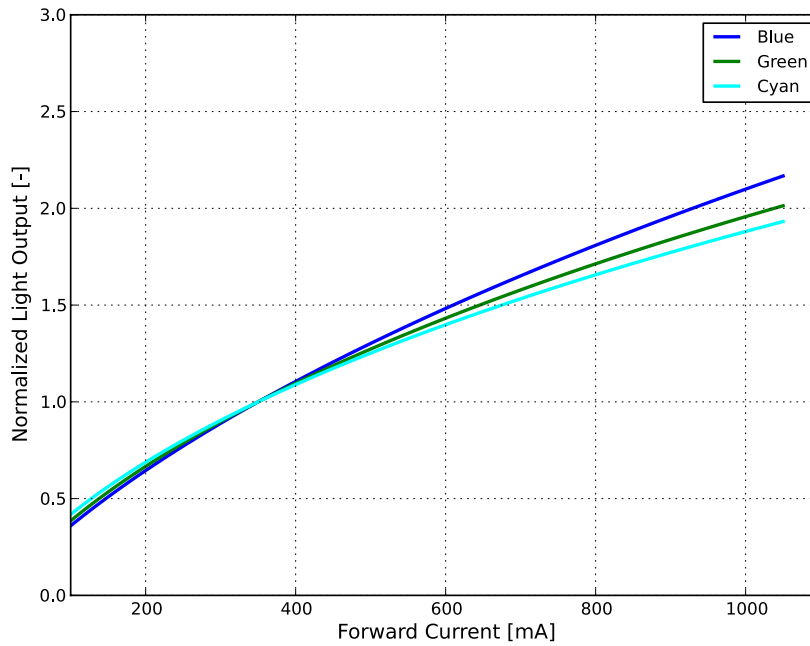

Figure 4c: Typical normalized light output vs. forward current for LUXEON C Cyan, Green and Blue at $T_j=85^\circ\text{C}$.

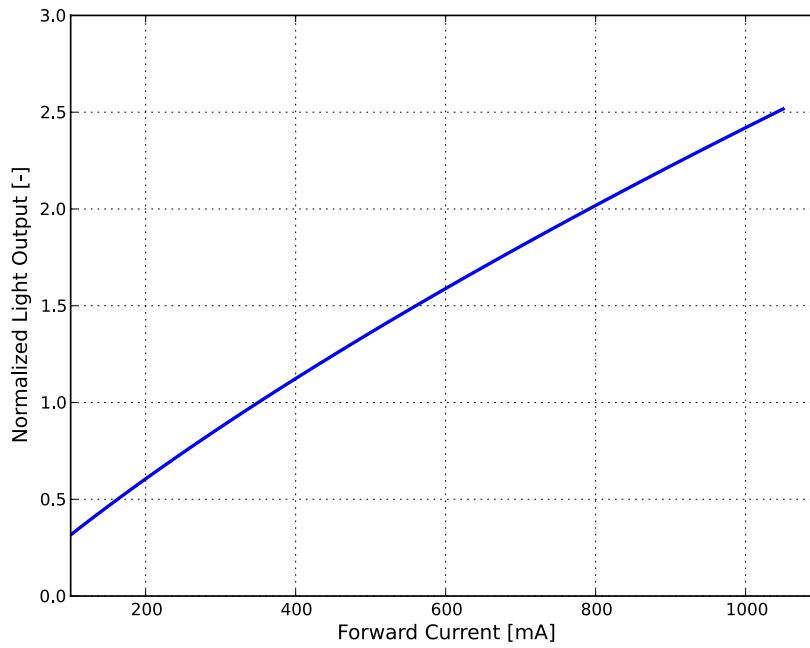

Figure 4d: Typical normalized light output vs. forward current for LUXEON C Royal Blue at $T_j=85^\circ\text{C}$.

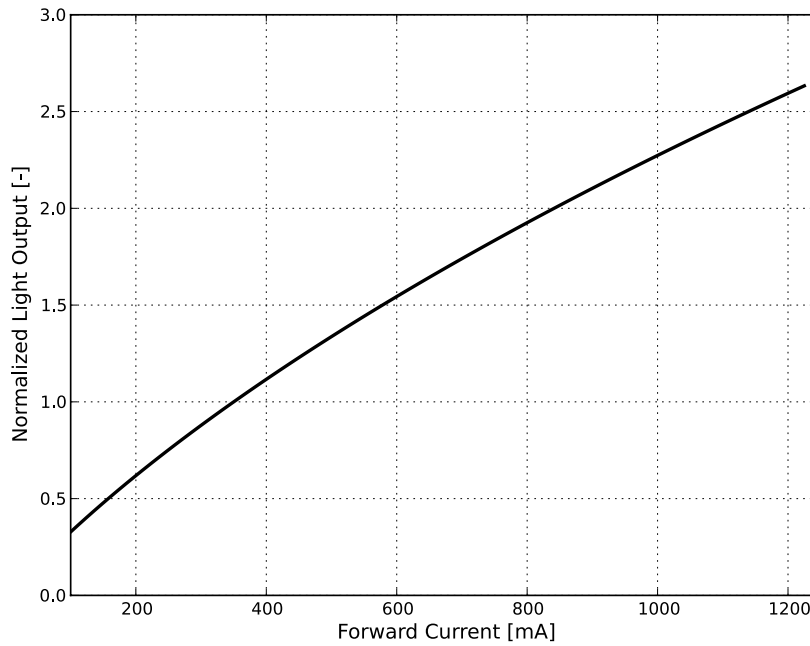

Figure 4e: Typical normalized light output vs. forward current for LUXEON C White at $T_j=85^\circ\text{C}$.

Forward Current Characteristics

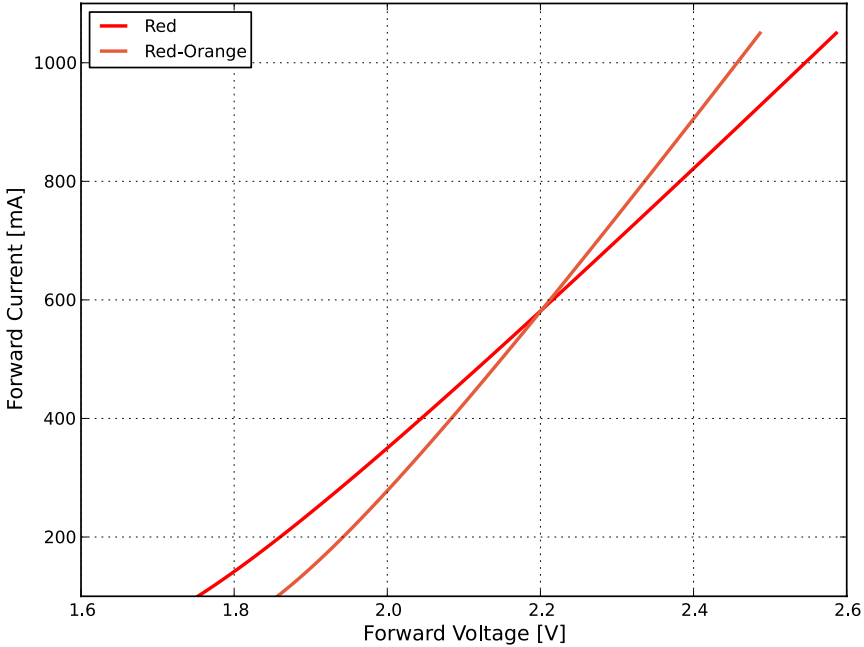

Figure 5a: Typical forward current vs. forward voltage for LUXEON C Red and Red-Orange at $T_j=85^\circ\text{C}$.

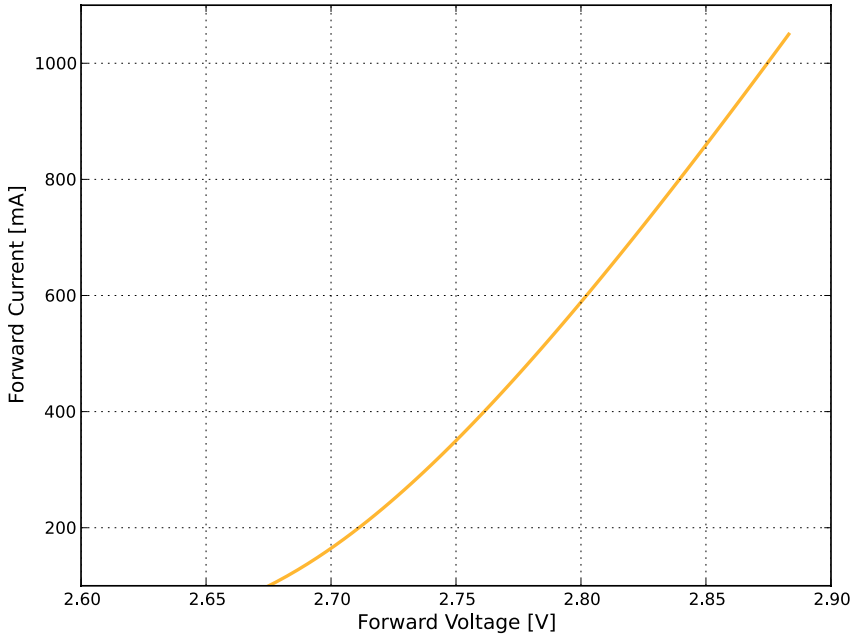

Figure 5b: Typical forward current vs. forward voltage for LUXEON C PC Amber at $T_j=85^\circ\text{C}$.

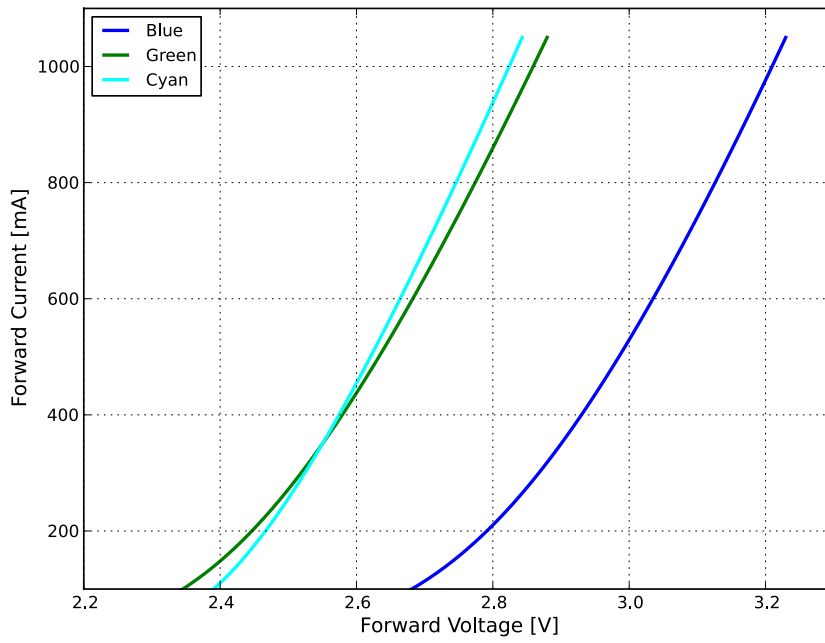

Figure 5c: Typical forward current vs. forward voltage for LUXEON C Cyan, Green and Blue at $T_j=85^\circ\text{C}$.

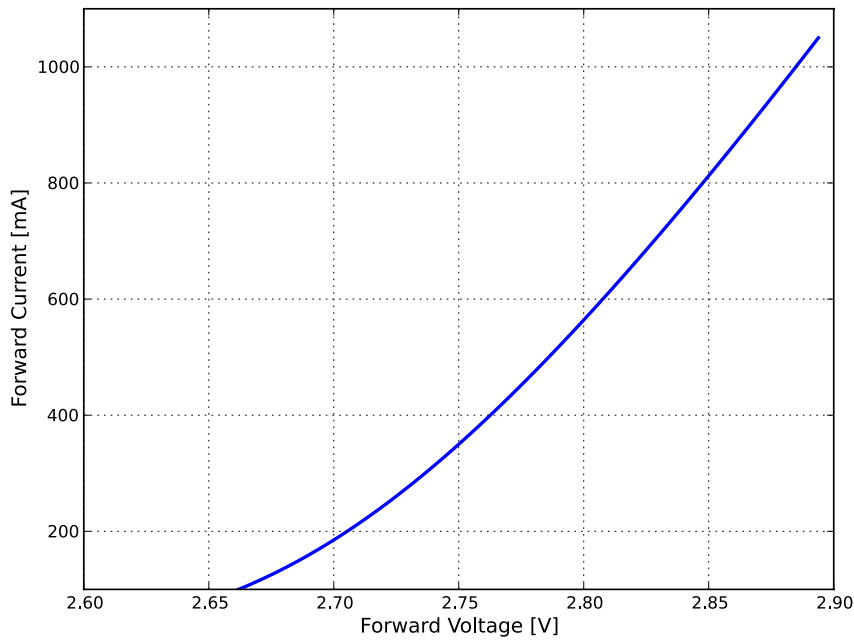

Figure 5d: Typical forward current vs. forward voltage for LUXEON C Royal Blue at $T_j=85^\circ\text{C}$.

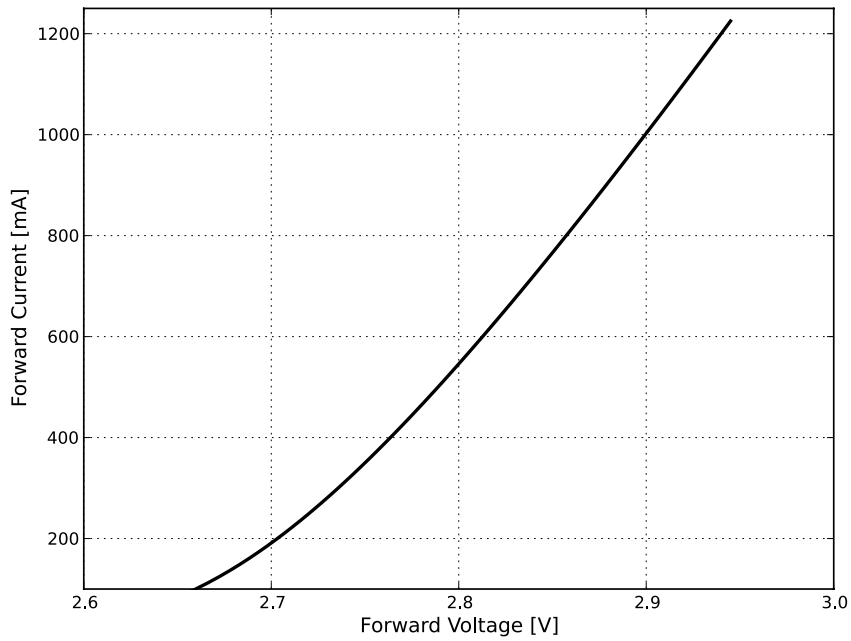

Figure 5e: Typical forward current vs. forward voltage for LUXEON C White at $T_j=85^\circ\text{C}$.

Radiation Pattern Characteristics

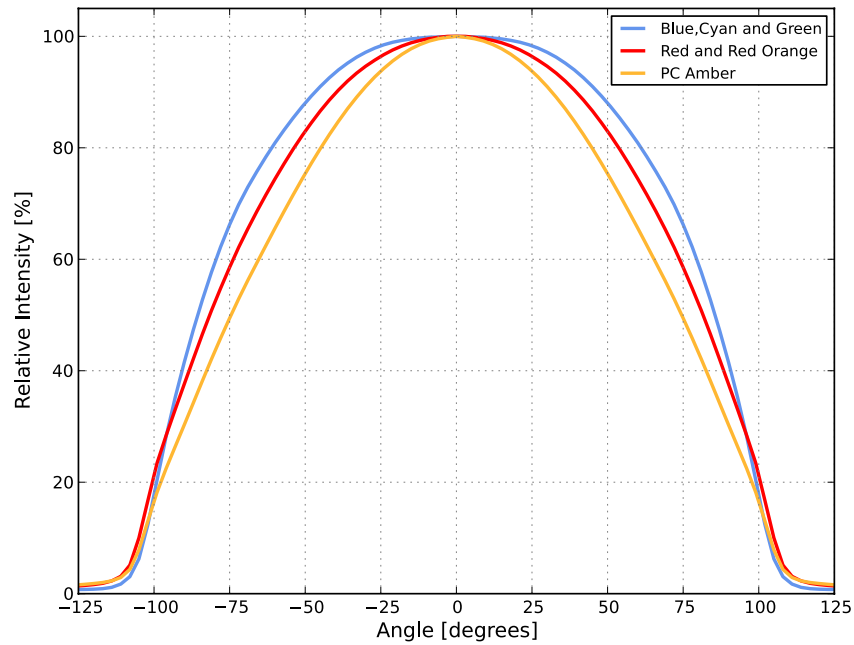

Figure 6a: Typical radiation pattern for LUXEON C Red, Red-Orange, PC Amber, Cyan, Green and Blue at 350mA, $T_j=85^\circ\text{C}$.

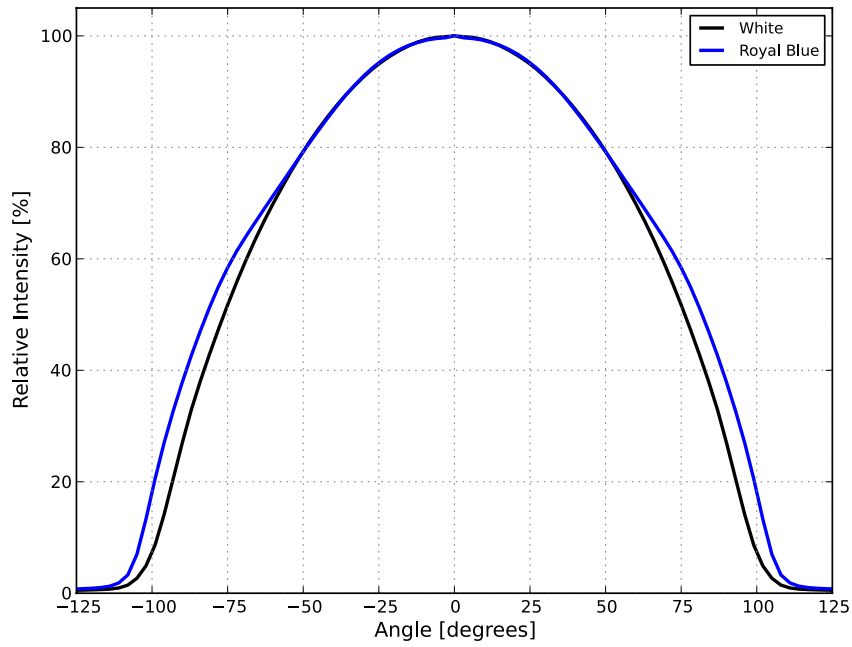

Figure 6b: Typical radiation pattern for LUXEON C Royal Blue and White at 350mA, $T_j=85^\circ\text{C}$.

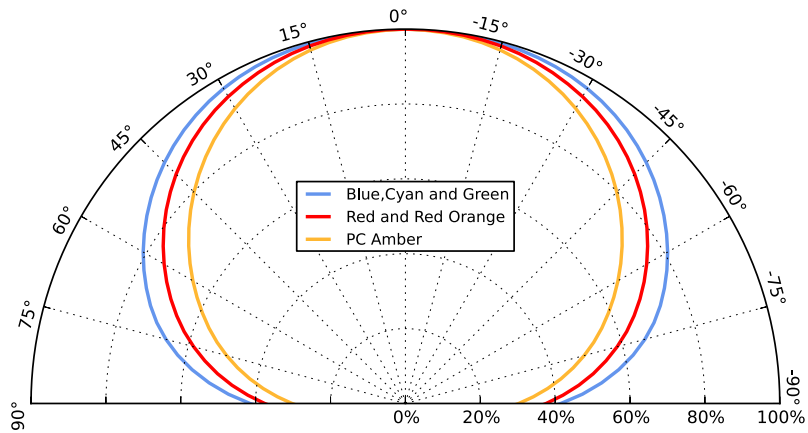

Figure 7a: Typical polar radiation pattern for LUXEON C Red, Red-Orange, PC Amber, Cyan, Green and Blue at 350mA, $T_j=85^\circ\text{C}$.

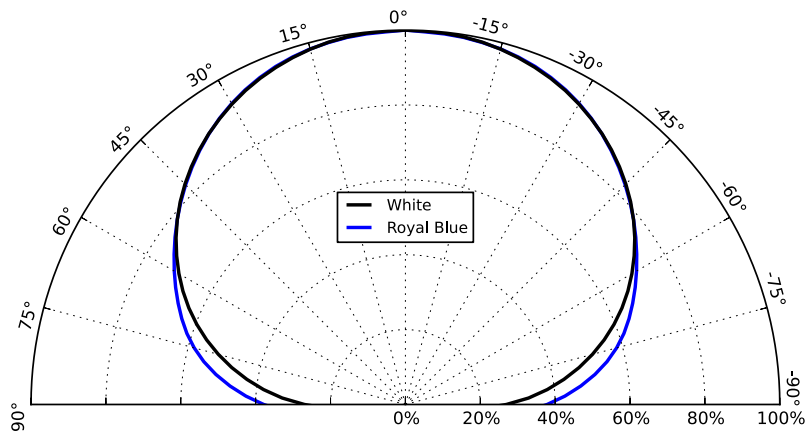

Figure 7b: Typical polar radiation pattern for LUXEON C Royal Blue and White at 350mA, $T_j=85^\circ\text{C}$.

Product Bin and Labeling Definitions

Decoding Product Bin Labeling

In the manufacturing of semiconductor products, there are variations in performance around the average values given in the technical datasheet. For this reason, Lumileds bins LED components for luminous flux, radiometric power, color point, peak wavelength, dominant wavelength and forward voltage.

LUXEON C Colors LEDs are labeled using a 4-digit alphanumeric CAT code following the format below:

A B C D

Where:

- A** – designates luminous flux or radiometric power bin (example: A=20 to 25 lumens, B= 25 to 30 lumens, H=480 to 520mW, J=520 to 560mW)
- B C** – designates color, peak or dominant wavelength bin (example: Red 40=624 to 634nm, Cyan 20=496 to 500nm, Royal Blue 50=450 to 455nm)
- D** – designates forward voltage bin (example: A=1.7 to 1.9V, B=1.9 to 2.1V)

Therefore, a LUXEON C Red LED with a lumen range of 20 to 25, a dominant wavelength of 624 to 634nm and a forward voltage range of 1.7 to 1.9V has the following CAT code:

A 4 0 A

Luminous Flux Bins

Table 5 lists the standard photometric luminous flux bins for LUXEON C Color Line emitters. Although several bins are outlined, product availability in a particular bin varies by production run and by product performance. Not all bins are available in all CCTs.

Table 5. Luminous flux bin definitions for LUXEON C Color Line.

BIN	LUMINOUS FLUX (lm)	
	MINIMUM	MAXIMUM
A	20	25
B	25	30
C	30	35
D	35	40
E	40	45
F	45	50
G	50	55
H	55	60
J	60	65
K	65	70
L	70	75
M	75	80
N	80	90
P	90	100
Q	100	110
R	110	120
S	120	130
T	130	140
U	140	150
V	150	170
W	170	190

Notes for Table 5:

1. Lumileds maintains a tolerance of $\pm 6.5\%$ on luminous flux measurements.

Radiometric Power Bins

Table 6. Radiometric power bin definitions for LUXEON C Royal Blue.

PART NUMBER	BIN	RADIOMETRIC POWER (mW)	
		MINIMUM	MAXIMUM
L1C1-RYL1000000000	H	480	520
	J	520	560
	K	560	600
	L	600	640

Notes for Table 6:

1. Lumileds maintains a tolerance of $\pm 6.5\%$ on radiometric power measurements.

Color Bin Definition

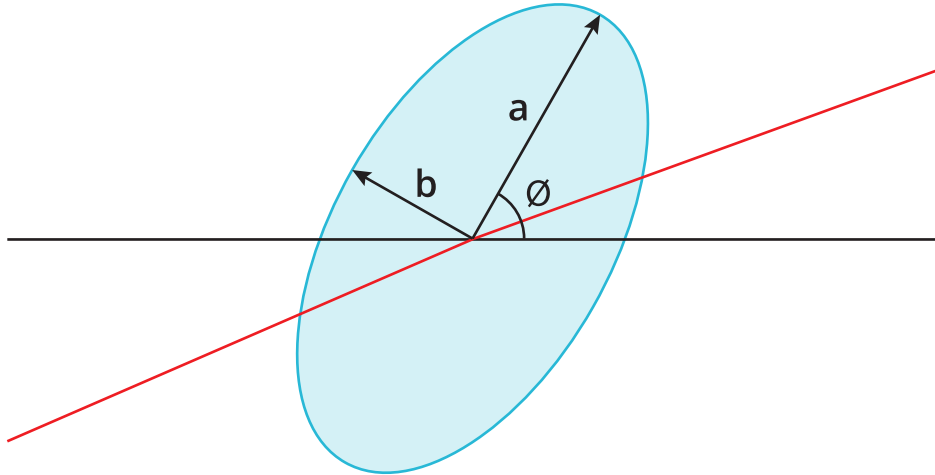

Figure 8: 3- and 5-step MacAdam ellipse illustration for Table 7.

Table 7. 3- and 5-step MacAdam ellipse color bin definitions for LUXEON C White at 350mA, $T_j = 85^\circ\text{C}$.

NOMINAL CCT	COLOR SPACE	CENTER POINT (cx, cy)	MAJOR AXIS, a	MINOR AXIS, b	ELLIPSE ROTATION ANGLE, θ
4000K	Single 5-step MacAdam ellipse	(0.3818, 0.3797)	0.01565	0.00670	53.7°
5700K	Single 5-step MacAdam ellipse	(0.3287, 0.3417)	0.01243	0.00533	59.1°

Notes for Table 7:

1. Lumileds maintains a tolerance of ± 0.005 on x and y coordinates in the CIE 1931 color space.

Dominant Wavelength Bins

Table 8a. Dominant wavelength bins for LUXEON C Color Line at 350mA, T_j=85°C.

PART NUMBER	BIN	DOMINANT WAVELENGTH (nm) ^[1]	
		MINIMUM	MAXIMUM
L1C1-RED1000000000	40	624	634
L1C1-RNG1000000000	20	614	624
L1C1-GRN1000000000	10	520	525
	20	525	530
	30	530	535
	40	535	540
L1C1-CYN1000000000	10	490	496
	20	496	500
	30	500	505
	40	505	510
L1C1-BLU1000000000	10	460	465
	20	465	470
	30	470	475
	40	475	480
	50	480	485

Notes for Table 8a:

1. Lumileds maintains a tolerance of ±0.5nm on dominant wavelength measurements.

Peak Wavelength Bins

Table 8b. Peak wavelength bins for LUXEON C Royal Blue.

PART NUMBER	BIN	PEAK WAVELENGTH (nm) ^[1]	
		MINIMUM	MAXIMUM
L1C1-RYL1000000000	30	440	445
	40	445	450
	50	450	455
	60	455	460

Notes for Table 8b:

1. Lumileds maintains a tolerance of ±0.5nm on peak wavelength measurements.

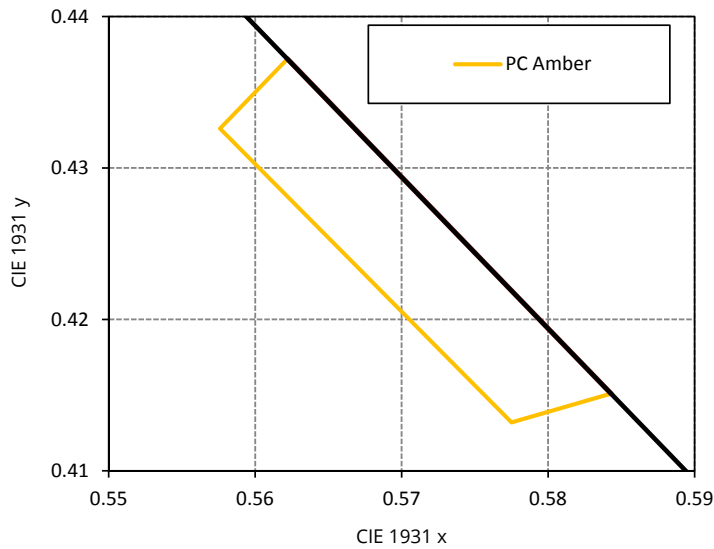

Figure 9: Color bin structure for LUXEON C PC Amber for Table 8c.

Table 8b. Peak wavelength bins for LUXEON C PC Amber.

PART NUMBER	BIN	x	y
L1C1-PCA1000000000	20	0.5622	0.4372
		0.5576	0.4326
		0.5775	0.4132
		0.5843	0.4151

Notes for Table 8b:

1. Lumileds maintains a tolerance of ± 0.005 on x and y color coordinates measurements.

Forward Voltage Bins

Table 9. Forward voltage bin definitions for LUXEON C Color Line.

BIN	FORWARD VOLTAGE (V) ⁽¹⁾	
	MINIMUM	MAXIMUM
A	1.70	1.90
B	1.90	2.10
C	2.10	2.30
D	2.30	2.50
E	2.50	2.70
F	2.70	2.90
G	2.90	3.10
H	3.10	3.30

Notes for Table 9:

1. Lumileds maintains a tolerance of $\pm 0.06V$ on forward voltage measurements.

Mechanical Dimensions

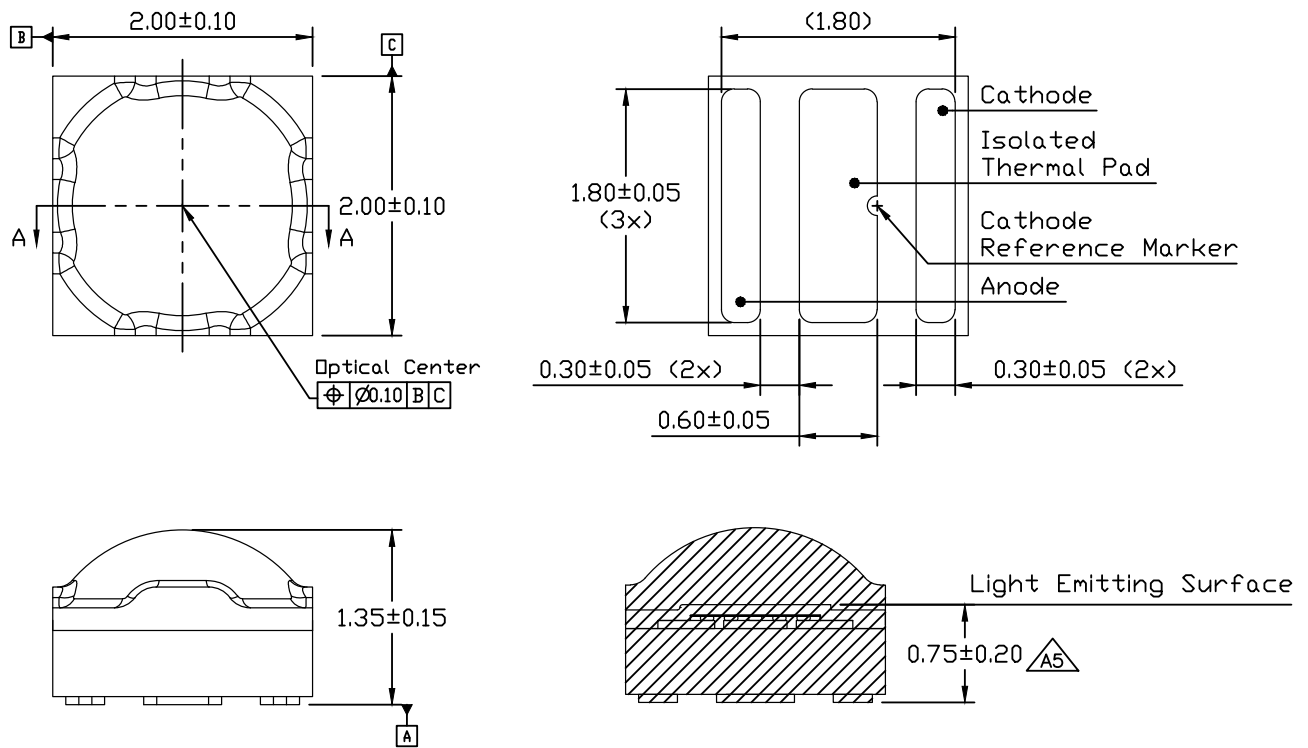

Figure 10: Mechanical dimensions for LUXEON C Color Line.

Notes for Figure 10:

1. Drawings are not to scale.
2. All dimensions are in millimeters.

Reflow Soldering Guidelines

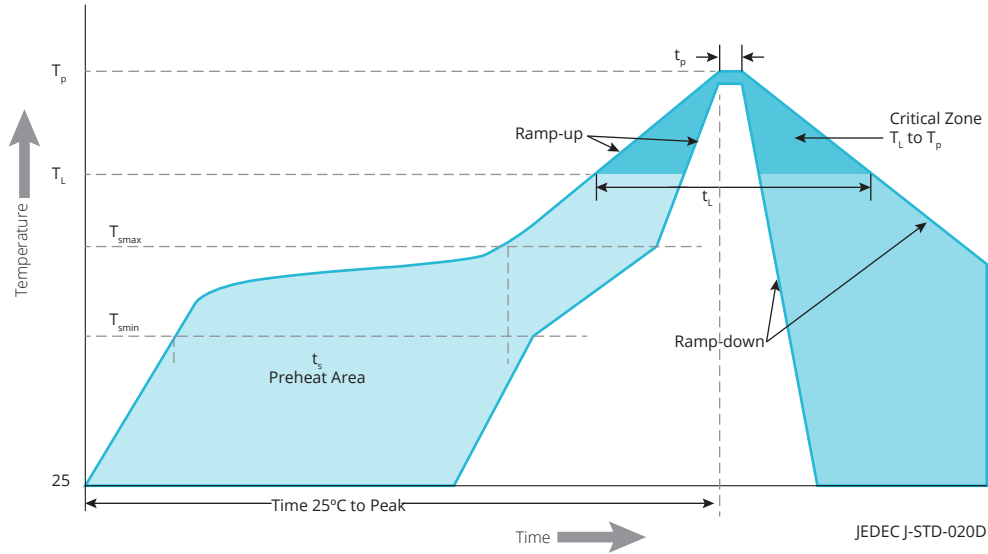

Figure 11: Visualization of the acceptable reflow temperature profile as specified in Table 10.

Table 10. Reflow profile characteristics for LUXEON C Color Line.

PROFILE FEATURE	LEAD-FREE ASSEMBLY
Preheat Minimum Temperature (T_{smin})	150°C
Preheat Maximum Temperature (T_{smax})	200°C
Preheat Time (t_{smin} to t_{smax})	60 to 120 seconds
Ramp-Up Rate (T_{smax} to T_p)	3°C / second maximum
Liquidus Temperature (T_L)	217°C
Time Maintained Above Temperature T_L (t_L)	10 to 30 seconds
Peak / Classification Temperature (T_p)	260°C
Time Within 5°C of Actual Temperature (t_p)	30 seconds
Ramp-Down Rate	6°C / second maximum
Time 25°C to Peak Temperature	8 minutes maximum

JEDEC Moisture Sensitivity

Table 11. Moisture sensitivity levels for LUXEON C LEDs.

LEVEL	FLOOR LIFE		SOAK REQUIREMENTS STANDARD	
	TIME	CONDITIONS	TIME	CONDITIONS
1	Unlimited	≤30°C / 85% RH	168 Hours +5 / -0	85°C / 85% RH

Solder Pad Design

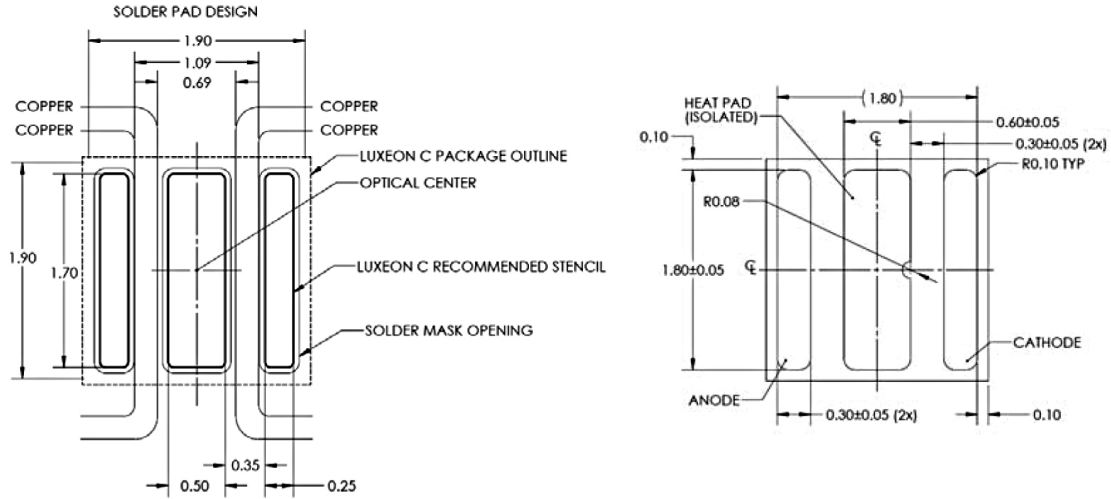

Figure 12: Recommended PCB solder pad layout for LUXEON C Color Line.

Notes for Figure 12:

1. Drawings are not to scale.
2. All dimensions are in millimeters.
3. The drawing above shows the recommended solder pad layout on Printed Circuit Board (PCB).

Packaging Information

Pocket Tape Dimensions

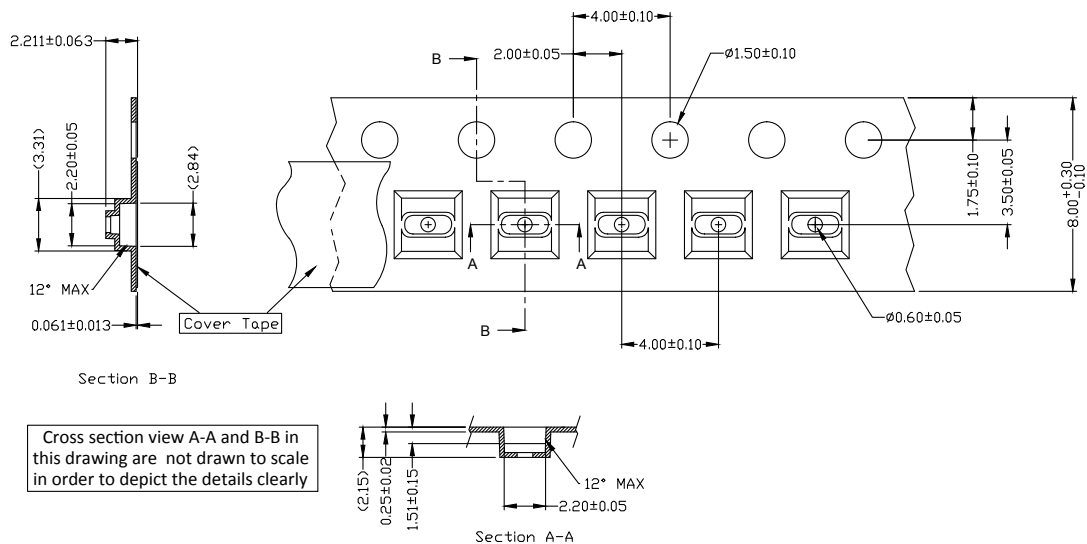

Figure 13: Pocket Tape dimensions for LUXEON C Color Line.

Notes for Figure 13:

1. Drawings are not to scale.
2. All dimensions are in millimeters.

About Lumileds

Lumileds is the light engine leader, delivering innovation, quality and reliability.

For 100 years, Lumileds commitment to innovation has helped customers pioneer breakthrough products in the automotive, consumer and illumination markets.

Lumileds is shaping the future of light with our LEDs and automotive lamps, and helping our customers illuminate how people see the world around them.

To learn more about our portfolio of light engines, visit lumileds.com.



©2015 Lumileds Holding B.V. All rights reserved.
LUXEON is a registered trademark of the Lumileds Holding B.V.
in the United States and other countries.
lumileds.com

Neither Lumileds Holding B.V. nor its affiliates shall be liable for any kind of loss of data or any other damages, direct, indirect or consequential, resulting from the use of the provided information and data. Although Lumileds Holding B.V. and/or its affiliates have attempted to provide the most accurate information and data, the materials and services information and data are provided "as is," and neither Lumileds Holding B.V. nor its affiliates warrants or guarantees the contents and correctness of the provided information and data. Lumileds Holding B.V. and its affiliates reserve the right to make changes without notice. You as user agree to this disclaimer and user agreement with the download or use of the provided materials, information and data.