



**SEMIPACK® 3**

## Rectifier Diode Modules

### SKKD 353/16

#### Features

- Industrial standard package
- Electrically insulated base plate
- Heat transfer through aluminum oxide ceramic insulated metal base plate
- Chip soldered on direct copper bonded Al<sub>2</sub>O<sub>3</sub> ceramic
- UL recognition applied for file no. E63532

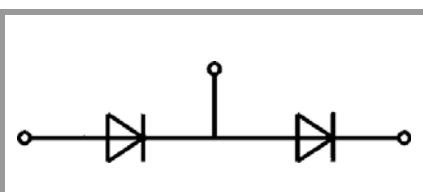

**SKKD**

Absolute Maximum Ratings				
Symbol	Conditions		Values	Unit
<b>Rectifier Diode</b>				
I <sub>FAV</sub>	sin. 180°	T <sub>c</sub> = 85 °C	350	A
		T <sub>c</sub> = 100 °C	260	A
I <sub>FRMS</sub>	continuous operation		580	A
I <sub>FSM</sub>	10 ms	T <sub>j</sub> = 25 °C	10500	A
		T <sub>j</sub> = 130 °C	9500	A
i <sup>2</sup> t	10 ms	T <sub>j</sub> = 25 °C	551250	A <sup>2</sup> s
		T <sub>j</sub> = 130 °C	451250	A <sup>2</sup> s
V <sub>RSM</sub>			1700	V
V <sub>RRM</sub>			1600	V
T <sub>j</sub>			-40 ... 130	°C
<b>Module</b>				
T <sub>stg</sub>			-40 ... 125	°C
V <sub>isol</sub>	a.c.; 50 Hz; r.m.s.	1 min	3000	V
		1 s	3600	V

Characteristics						
Symbol	Conditions		min.	typ.	max.	Unit
<b>Diode</b>						
V <sub>F</sub>	T <sub>j</sub> = 25 °C, I <sub>F</sub> = 750 A				1.38	V
V <sub>(TO)</sub>	T <sub>j</sub> = 130 °C				0.84	V
r <sub>T</sub>	T <sub>j</sub> = 130 °C				0.67	mΩ
I <sub>RD</sub>	T <sub>j</sub> = 130 °C, V <sub>RD</sub> = V <sub>RRM</sub>				15	mA
R <sub>th(j-c)</sub>	cont.	per chip			0.09	K/W
		per module			0.045	K/W
R <sub>th(j-c)</sub>	sin. 180°	per chip			0.092	K/W
		per module			0.046	K/W
<b>Module</b>						
R <sub>th(c-s)</sub>	chip			0.08		K/W
	module			0.04		K/W
M <sub>s</sub>	to heatsink M5		4.25		5.75	Nm
M <sub>t</sub>	to terminals M8		7.65		10.35	Nm
a					5 * 9,81	m/s <sup>2</sup>
w				410		g

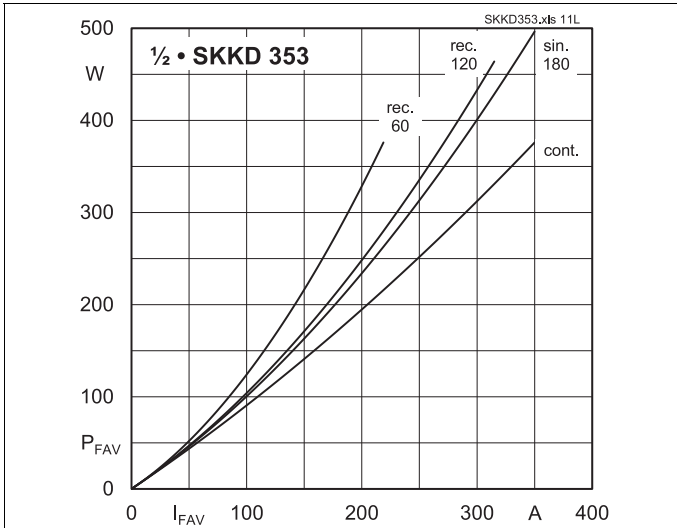

Fig. 11L: Power dissipation per diode vs. forward current

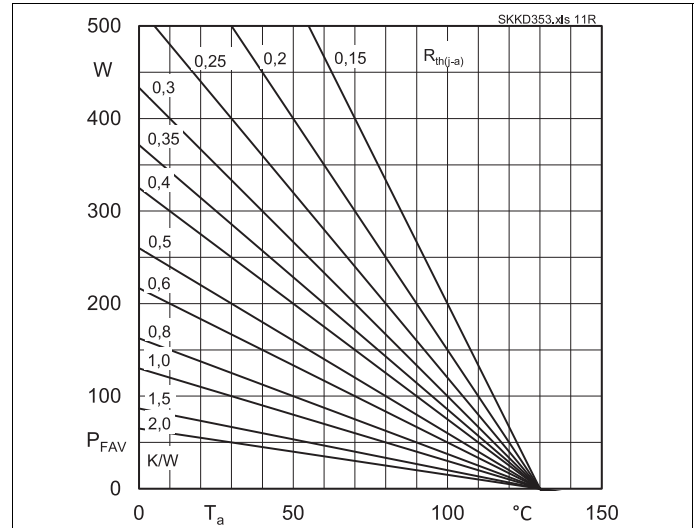

Fig. 11R: Power dissipation per diode vs. ambient temperature

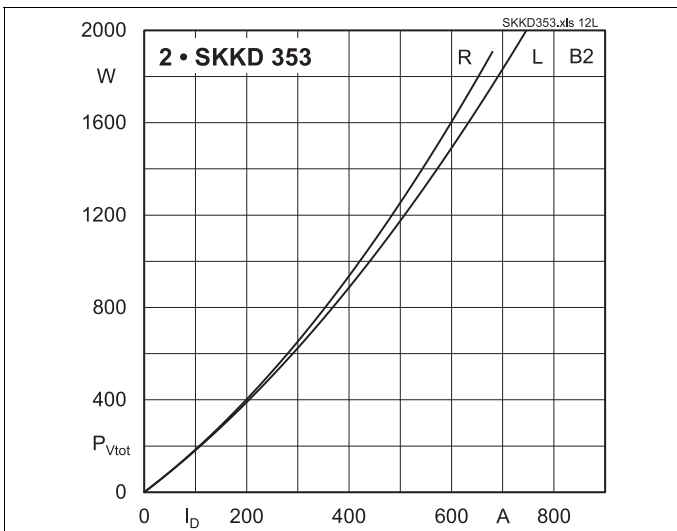

Fig. 12L: Power dissipation of two modules vs. direct current

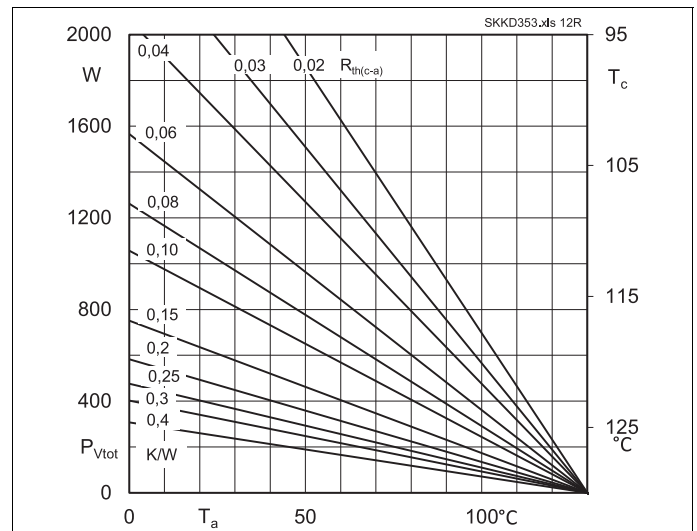

Fig. 12R: Power dissipation of two modules vs. case temperature

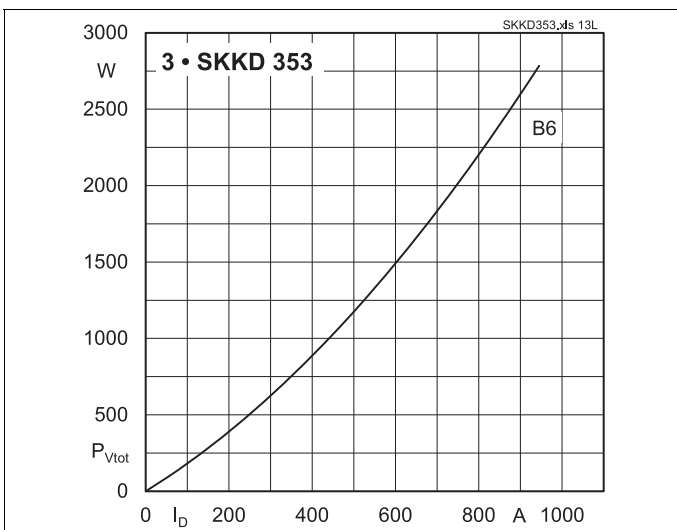

Fig. 13L: Power dissipation of three modules vs. direct current

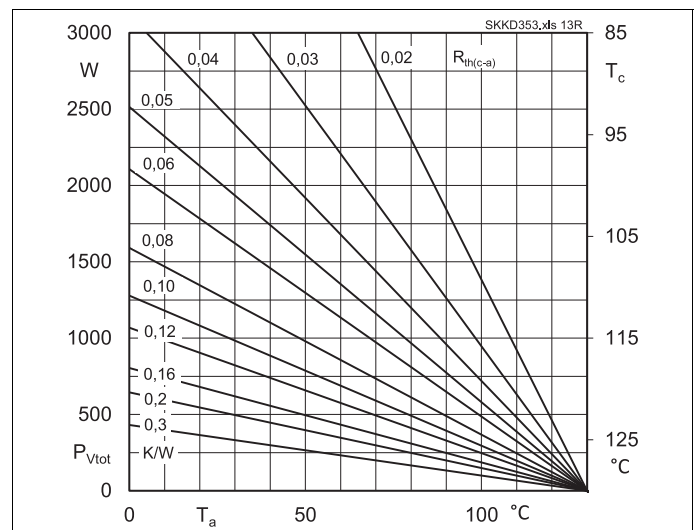

Fig. 13R: Power dissipation of three modules vs. case temperature

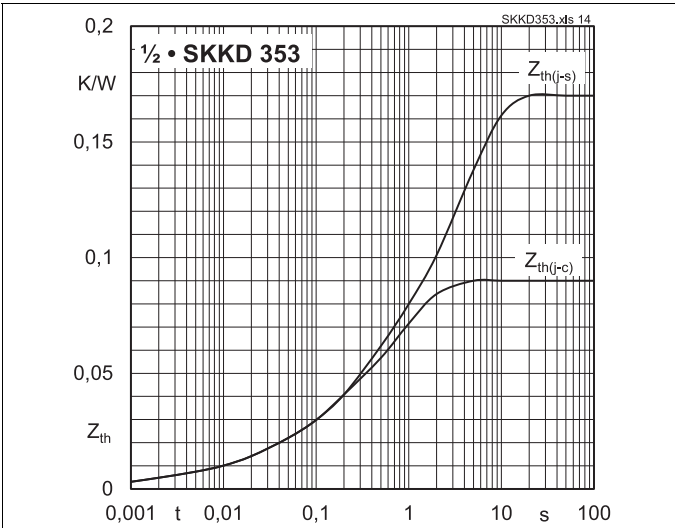

Fig. 14: Transient thermal impedance vs. time

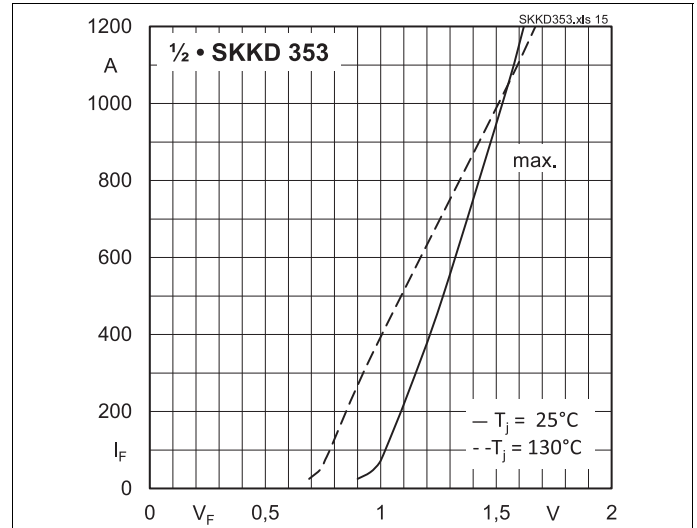

Fig. 15: Forward characteristics

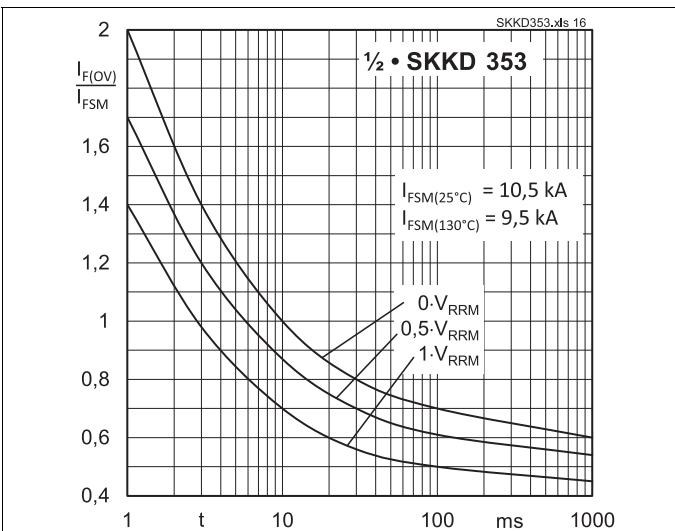
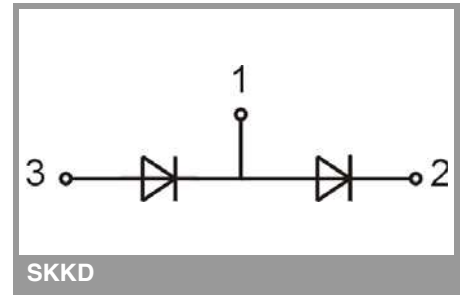
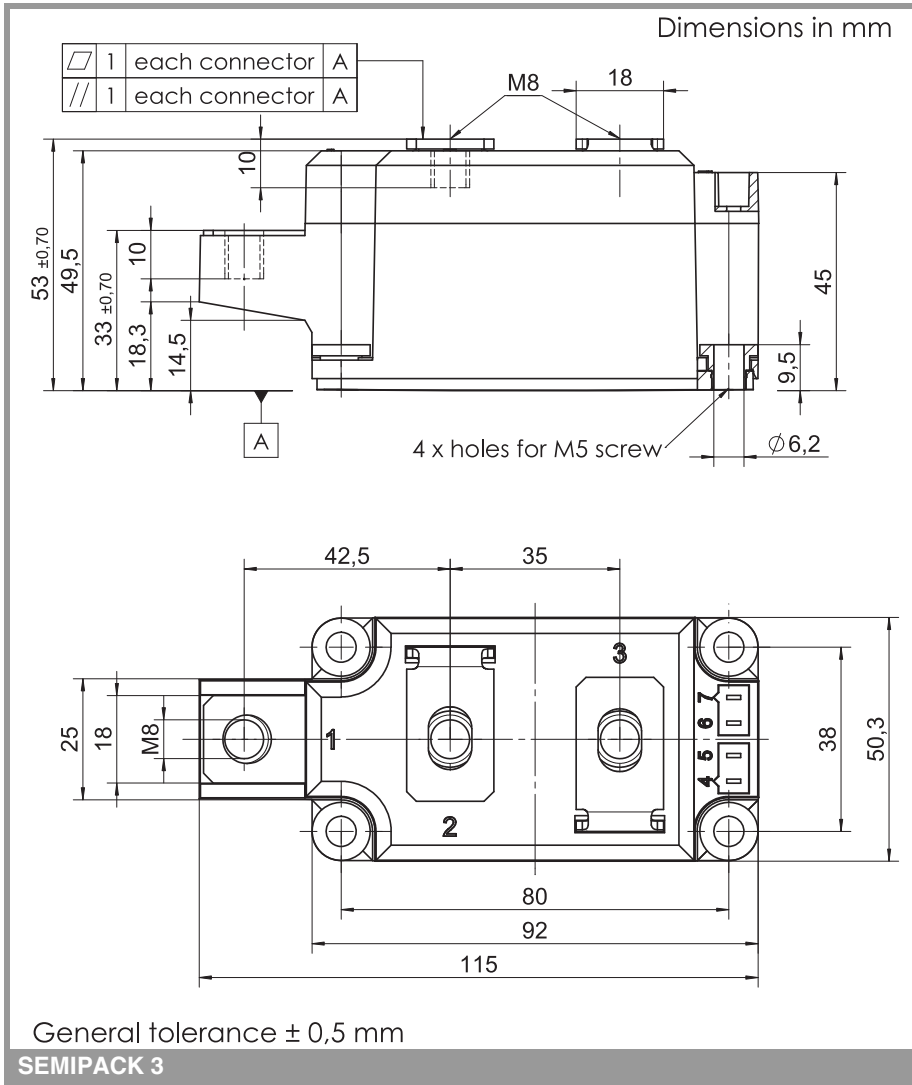

Fig. 16: Surge overload current vs. time



This is an electrostatic discharge sensitive device (ESDS), international standard IEC 60747-1, Chapter IX

\* The specifications of our components may not be considered as an assurance of component characteristics. Components have to be tested for the respective application. Adjustments may be necessary. The use of SEMIKRON products in life support appliances and systems is subject to prior specification and written approval by SEMIKRON. We therefore strongly recommend prior consultation of our staff.