

Zener Diodes

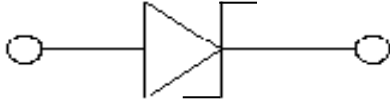

Features

- High reliability
- Very sharp reverse characteristic
- Low reverse current level
- Zener Voltage 2.4V~75V

Mechanical Data

- **Package:** SOD-123
- **Terminals:** Tin plated leads, solderable per J-STD-002 and JESD22-B102
- **Polarity:** Cathode line denotes the cathode end

■ Maximum Ratings (T_a=25°C Unless otherwise specified)

PARAMETER	SYMBOL	UNIT	VALUE
Power Dissipation	P _D	mW	500
Storage Temperature Range	T _{stg}	°C	-55~+150
Junction Temperature	T _J	°C	-55~+150
Maximum Regulator Current	I _{ZM}	mA	P _D / V _Z
Forward Voltage(@I _F =10mA)	V _F	V	1.0
Thermal Resistance Junction to Ambient Air*	R _{θJA}	°C /W	250

■ Ordering Information (Example)

PREFERRED P/N	PACKING CODE	UNIT WEIGHT(g)	MINIMUM PACKAGE(pcs)	INNER BOX QUANTITY(pcs)	OUTER CARTON QUANTITY(pcs)	DELIVERY MODE
BZT52B2V4 THRU BZT52B75	F2	Approximate 0.011	3000	30000	120000	7" reel



BZT52B2V4 THRU BZT52B75

■ Electrical Characteristics (T_a=25°C Unless otherwise specified)

Type Number	Device Marking	V _z at I _{ZT} (V)			Z _{zt} (Ω)		Z _{zk} (Ω)		I _R (μA)@V _R		Typical Temperature Coefficient@ IZTC mV/°C		Test Current IZTC
		min.	typ.	max.	I _{ZT} (mA)	max.	I _{zk} (mA)	max.	max	V _R (V)	Min	Max	mA
BZT52B2V4	2WX	2.34	2.4	2.46	5	100	1.0	600	45	1.0	-3.5	0	5
BZT52B2V7	2W1	2.633	2.7	2.768	5	100	1.0	600	20	1.0	-3.5	0	5
BZT52B3V0	2W2	2.925	3.0	3.075	5	100	1.0	600	10	1.0	-3.5	0	5
BZT52B3V3	2W3	3.218	3.3	3.383	5	95	1.0	600	15	1.0	-3.5	0	5
BZT52B3V6	2W4	3.53	3.6	3.67	5	95	1.0	600	15	1.0	-3.5	0	5
BZT52B3V9	2W5	3.82	3.9	3.98	5	95	1.0	600	10	1.0	-3.5	0	5
BZT52B4V3	2W6	4.21	4.3	4.39	5	95	1.0	600	5	1.0	-3.5	0	5
BZT52B4V7	2W7	4.61	4.7	4.79	5	78	1.0	500	5	2.0	-3.5	0	5
BZT52B5V1	2W8	5.0	5.1	5.2	5	60	1.0	480	0.1	0.8	-2.7	1.2	5
BZT52B5V6	2W9	5.49	5.6	5.71	5	40	1.0	400	0.1	1.0	-2	2.5	5
BZT52B6V2	2WA	6.08	6.2	6.32	5	10	1.0	150	0.1	2.0	0.4	3.7	5
BZT52B6V8	2WB	6.66	6.8	6.94	5	8	1.0	80	0.1	3.0	1.2	4.5	5
BZT52B7V5	2WC	7.35	7.5	7.65	5	7	1.0	80	0.1	5.0	2.5	5.3	5
BZT52B8V2	2WD	8.04	8.2	8.36	5	7	1.0	80	0.1	6.0	3.2	6.2	5
BZT52B9V1	2WE	8.92	9.1	9.28	5	10	1.0	100	0.1	7.0	3.8	7.0	5
BZT52B10	2WF	9.8	10	10.2	5	15	1.0	150	0.1	7.5	4.5	8.0	5
BZT52B11	2WG	10.78	11	11.22	5	20	1.0	150	0.1	8.5	5.4	9.0	5
BZT52B12	2WH	11.76	12	12.24	5	20	1.0	150	0.1	9.0	6.0	10.0	5
BZT52B13	2WI	12.74	13	13.26	5	25	1.0	170	0.1	10.0	7.0	11.0	5
BZT52B14	WJ	13.7	14	14.3	5	30	1.0	170	0.1	10.5	8.1	12.0	5
BZT52B15	2WJ	14.7	15	15.3	5	30	1.0	200	0.1	11.0	9.2	13.0	5
BZT52B16	2WK	15.68	16	16.3	5	40	1.0	200	0.1	12	10.4	14.0	5
BZT52B18	2WL	17.64	18	18.36	5	50	1.0	225	0.1	14.0	12.4	16.0	5
BZT52B20	2WM	19.6	20	20.4	5	55	1.0	225	0.1	15.0	14.4	18.0	5
BZT52B22	2WN	21.56	22	22.44	5	55	1.0	250	0.1	17.0	16.4	20.0	5
BZT52B24	2WO	23.52	24	24.48	5	70	1.0	250	0.1	18.0	18.4	22.0	5
BZT52B27	2WP	26.46	27	27.54	5	80	1.0	300	0.1	20.0	21.4	25.3	2
BZT52B30	2WQ	29.4	30	30.6	5	80	1.0	300	0.1	22.5	24.4	29.4	2
BZT52B33	2WR	32.34	33	33.66	5	80	1.0	325	0.1	25.0	27.4	33.4	2
BZT52B36	2WS	35.28	36	36.72	5	90	1.0	350	0.1	27.0	30.4	37.4	2
BZT52B39	2WT	38.22	39	39.78	5	90	1.0	350	0.1	29.0	33.4	41.2	2
BZT52B43	2WU	42.14	43	43.86	5	100	1	375	0.1	32.0	37.6	46.6	2
BZT52B47	2WV	46.06	47	47.94	5	110	1	375	0.1	35.0	42.0	51.8	2
BZT52B51	2X1	50.0	51	52.0	2	180	0.5	400	0.05	35.7	46.6	57.2	2
BZT52B56	2X2	54.9	56	57.1	2	200	0.5	425	0.05	39.2	52.2	63.8	2
BZT52B62	X3	60.8	62	63.2	2	215	0.5	450	0.05	43.4	58.8	71.6	2
BZT52B68	X4	66.64	68	69.36	2	240	0.5	475	0.05	47.6	65.6	79.8	2
BZT52B75	X5	73.5	75	76.5	2	255	0.5	500	0.05	52.5	73.4	88.6	2



BZT52B2V4 THRU BZT52B75

■ Characteristics (Typical)

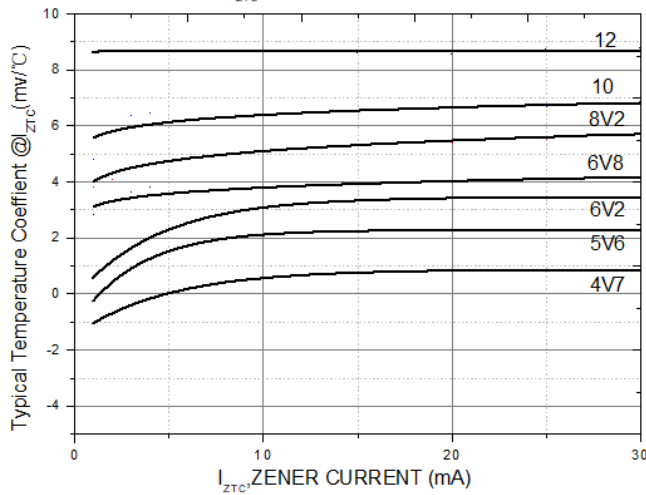
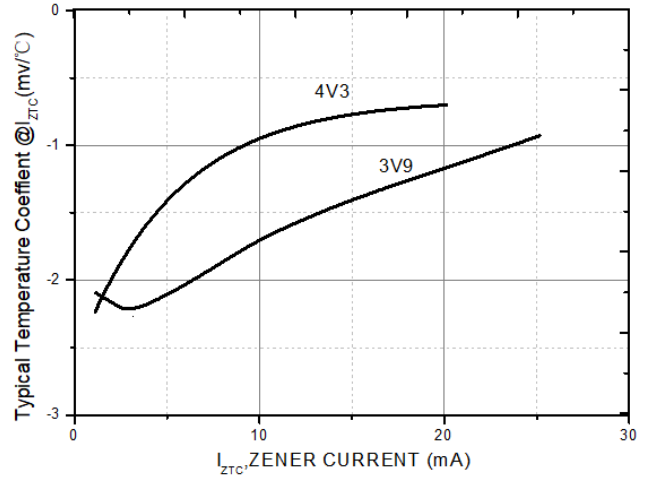
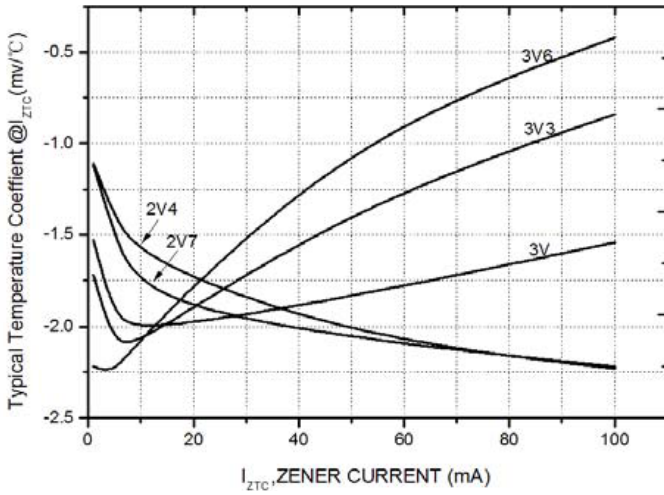
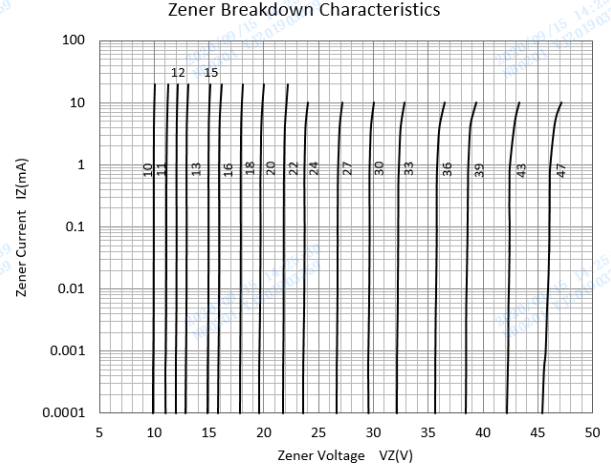
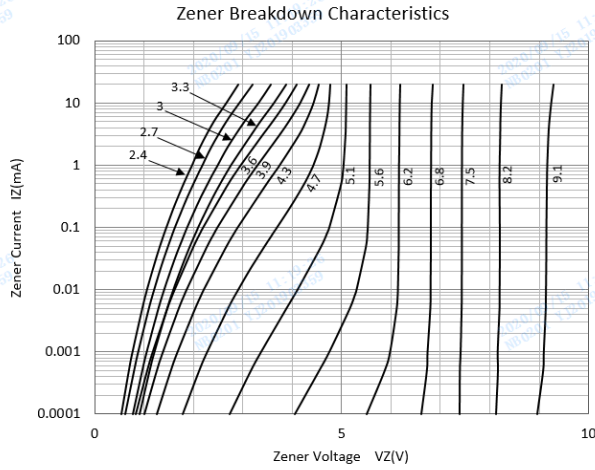



BZT52B2V4 THRU BZT52B75

■ Outline Dimensions

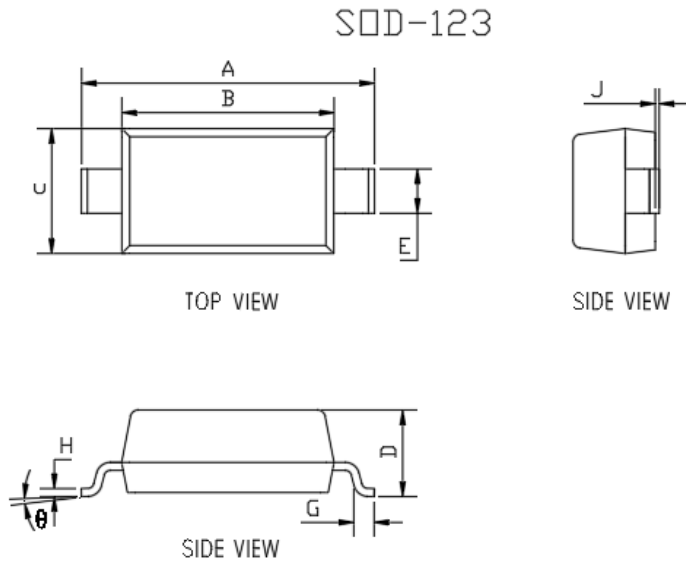

DIMENSIONS				
DIM	INCHES		MM	
	MIN	MAX	MIN	MAX
A	0.140	0.152	3.550	3.850
B	0.100	0.112	2.550	2.850
C	0.055	0.071	1.400	1.800
D	0.037	0.053	0.950	1.350
E	0.020	0.028	0.510	0.710
G	0.006	0.018	0.150	0.450
H	0.003	0.010	0.080	0.250
J	0.000	0.006	0.000	0.150
θ	0	8°	0	8°

■ Soldering Footprint

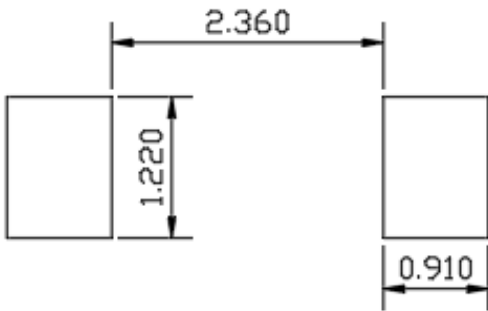

UNIT : mm

SUGGESTED SOLDER PAD LAYOUT



BZT52B2V4 THRU BZT52B75

Disclaimer

The information presented in this document is for reference only. Yangzhou Yangjie Electronic Technology Co., Ltd. reserves the right to make changes without notice for the specification of the products displayed herein to improve reliability, function or design or otherwise.

The product listed herein is designed to be used with ordinary electronic equipment or devices, and not designed to be used with equipment or devices which require high level of reliability and the malfunction of which would directly endanger human life (such as medical instruments, transportation equipment, aerospace machinery, nuclear-reactor controllers, fuel controllers and other safety devices), Yangjie or anyone on its behalf, assumes no responsibility or liability for any damages resulting from such improper use of sale.

This publication supersedes & replaces all information previously supplied. For additional information, please visit our website [http:// www.21yangjie.com](http://www.21yangjie.com) , or consult your nearest Yangjie's sales office for further assistance.