

Zener Diodes

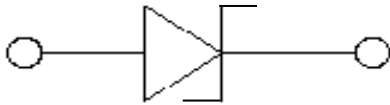

Features

- High reliability
- Very sharp reverse characteristic
- Low reverse current level
- Zener Voltage 2.4V~75V



Mechanical Data

- **Package:** SOD-323
- **Terminals:** Tin plated leads, solderable per J-STD-002 and JESD22-B102
- **Polarity:** Cathode line denotes the cathode end

■Maximum Ratings ($T_a=25^\circ\text{C}$ Unless otherwise specified)

PARAMETER	SYMBOL	UNIT	VALUE
Power Dissipation(*Note)	P_D	mW	300
Storage Temperature Range	T_{stg}	$^\circ\text{C}$	-55~+150
Junction Temperature	T_J	$^\circ\text{C}$	-55~+150
Maximum Forward Voltage @ $I_F=10\text{mA}$	V_F	V	0.9
Maximum Regulator Current	I_{ZM}	mA	P_D / V_z
Thermal Resistance Junction to Ambient Air(*Note)	$R_{\theta JA}$	$^\circ\text{C} / \text{W}$	417

Note:Device mounted on PCB

■Ordering Information (Example)

PREFERED P/N	PACKING CODE	UNIT WEIGHT(g)	MINIMUM PACKAGE(pcs)	INNER BOX QUANTITY(pcs)	OUTER CARTON QUANTITY(pcs)	DELIVERY MODE
BZT52B2V4S THRU BZT52B75S	F2	Approximate 0.0048	3000	30000	120000	7" reel



BZT52B2V4S THRU BZT52B75S

■Electrical Characteristics (T_a=25°C Unless otherwise specified)

Type Number	Device Marking	V _z at I _{ZT} (V)			Z _{z1} (Ω)		Z _{zk} (Ω)		I _R (μA)@V _R		Typical Temperature Coefficient@ IZTC mV/°C	
		min.	typ.	max.	I _{ZT} (mA)	max.	I _{zk} (mA)	max.	max	V _R (V)	Min	Max
BZT52B2V4S	2WX	2.34	2.4	2.46	5	100	1.0	600	45	1.0	-3.5	0
BZT52B2V7S	2W1	2.633	2.7	2.768	5	100	1.0	600	20	1.0	-3.5	0
BZT52B3V0S	2W2	2.925	3.0	3.075	5	100	1.0	600	9	1.0	-3.5	0
BZT52B3V3S	2W3	3.218	3.3	3.383	5	95	1.0	600	4.5	1.0	-3.5	0
BZT52B3V6S	2W4	3.53	3.6	3.67	5	95	1.0	600	15	1.0	-3.5	0
BZT52B3V9S	2W5	3.82	3.9	3.98	5	95	1.0	600	10	1.0	-3.5	0
BZT52B4V3S	2W6	4.21	4.3	4.39	5	95	1.0	600	5	1.0	-3.5	0
BZT52B4V7S	2W7	4.61	4.7	4.79	5	78	1.0	500	5	2.0	-3.5	0
BZT52B5V1S	2W8	5.0	5.1	5.2	5	60	1.0	480	0.1	0.8	-2.7	1.2
BZT52B5V6S	2W9	5.49	5.6	5.71	5	40	1.0	400	0.1	1.0	-2	2.5
BZT52B6V2S	2WA	6.08	6.2	6.32	5	10	1.0	150	0.1	2.0	0.4	3.7
BZT52B6V8S	2WB	6.66	6.8	6.94	5	8	1.0	80	0.1	3.0	1.2	4.5
BZT52B7V5S	2WC	7.35	7.5	7.65	5	7	1.0	80	0.1	5.0	2.5	5.3
BZT52B8V2S	2WD	8.04	8.2	8.36	5	7	1.0	80	0.1	6.0	3.2	6.2
BZT52B9V1S	2WE	8.92	9.1	9.28	5	10	1.0	100	0.1	7.0	3.8	7.0
BZT52B10S	WG	9.8	10	10.2	5	15	1.0	150	0.1	7.5	4.5	8.0
BZT52B11S	2WG	10.78	11	11.22	5	20	1.0	150	0.1	8.5	5.4	9.0
BZT52B12S	WI	11.76	12	12.24	5	20	1.0	150	0.1	9.0	6.0	10.0
BZT52B13S	2WI	12.74	13	13.26	5	25	1.0	170	0.1	10.0	7.0	11.0
BZT52B14S	WJ	13.7	14	14.3	5	30	1.0	170	0.1	10.2	8.1	12.0
BZT52B15S	WL	14.7	15	15.3	5	30	1.0	200	0.1	11.0	9.2	13.0
BZT52B16S	WM	15.68	16	16.3	5	40	1.0	200	0.1	12	10.4	14.0
BZT52B18S	WN	17.64	18	18.36	5	50	1.0	225	0.1	14.0	12.4	16.0
BZT52B20S	2WM	19.6	20	20.4	5	55	1.0	225	0.1	15.0	14.4	18.0
BZT52B22S	2WN	21.56	22	22.44	5	55	1.0	250	0.1	17.0	16.4	20.0
BZT52B24S	WR	23.52	24	24.48	5	70	1.0	250	0.1	18.0	18.4	22.0
BZT52B27S	2WP	26.46	27	27.54	5	80	1.0	300	0.1	20.0	21.4	25.3
BZT52B30S	2WQ	29.4	30	30.6	5	80	1.0	300	0.1	22.5	24.4	29.4
BZT52B33S	2WR	32.34	33	33.66	5	80	1.0	325	0.1	25.0	27.4	33.4
BZT52B36S	2WS	35.28	36	36.72	5	90	1.0	350	0.1	27.0	30.4	37.4
BZT52B39S	2WT	38.22	39	39.78	5	90	1.0	350	0.1	29.0	33.4	41.2
BZT52B43S	2WU	42.14	43	43.86	5	100	1	375	0.1	32.0	37.6	46.6
BZT52B47S	2WV	46.06	47	47.94	5	110	1	375	0.1	35.0	42.0	51.8
BZT52B51S	2X1	50.0	51	52.0	2	180	0.5	400	0.05	35.7	46.6	57.2
BZT52B56S	2X2	54.9	56	57.1	2	200	0.5	425	0.05	39.2	52.2	63.8
BZT52B62S	2X3	60.8	62	63.2	2	215	0.5	450	0.05	43.4	58.8	71.6
BZT52B68S	2X4	66.64	68	69.36	2	240	0.5	475	0.05	47.6	65.6	79.8
BZT52B75S	2X5	73.5	75	76.5	2	255	0.5	500	0.05	52.5	73.4	88.6



BZT52B2V4S THRU BZT52B75S

■ Characteristics (Typical)

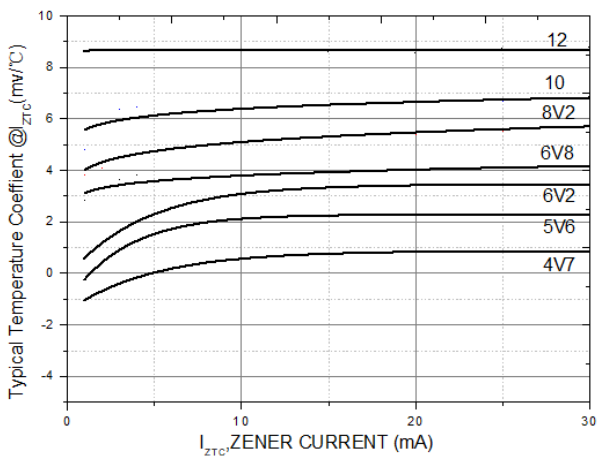
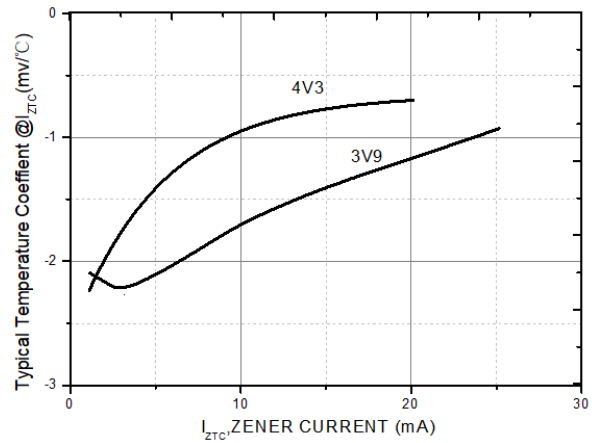
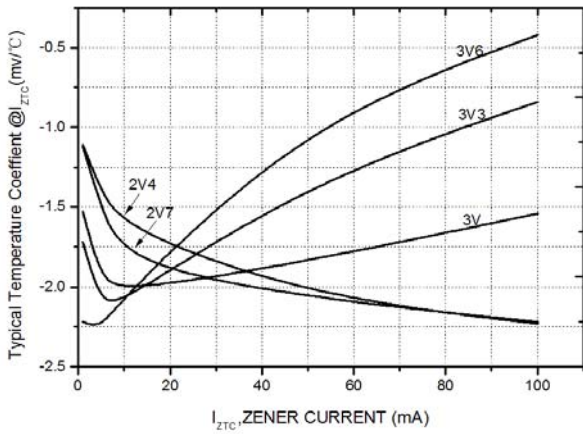
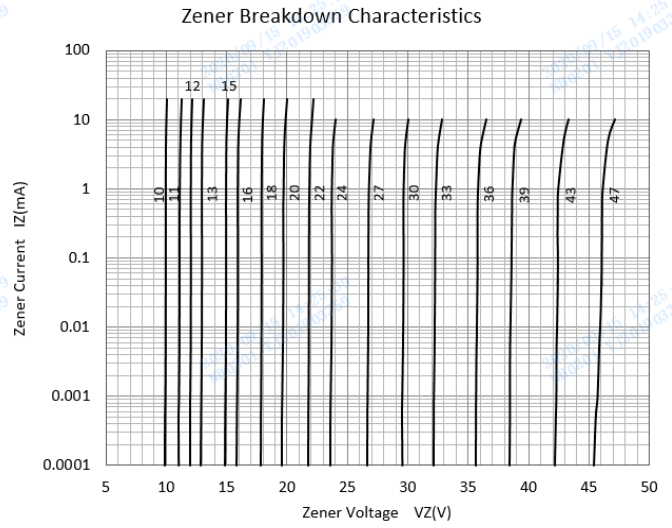
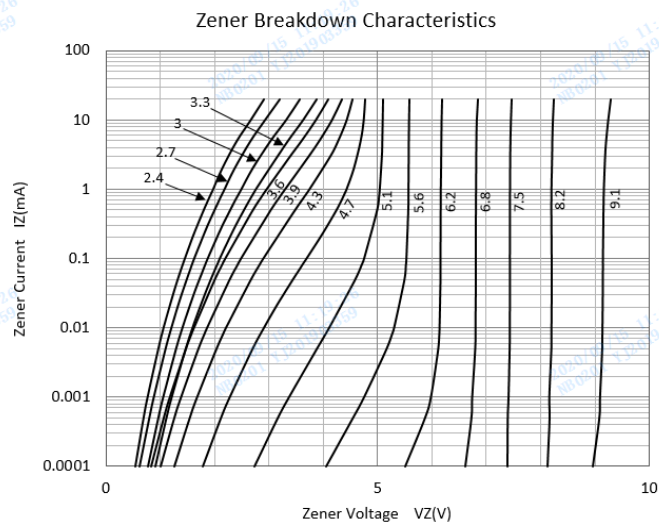



BZT52B2V4S THRU BZT52B75S

■Outline Dimensions

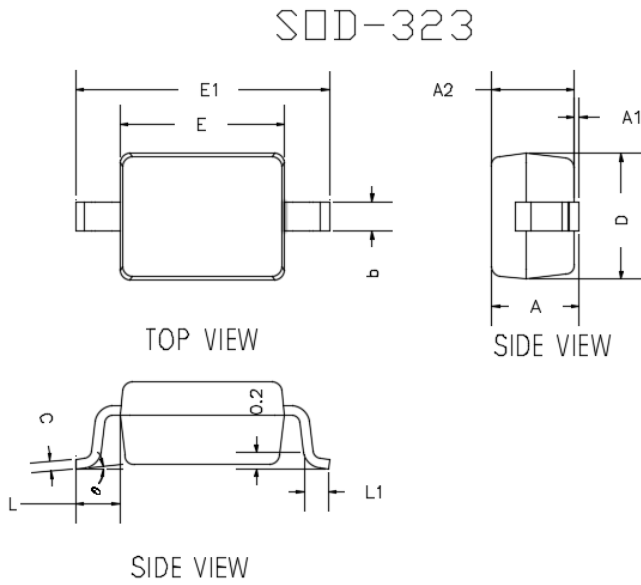

DIMENSIONS				
DIM	INCHES		MM	
	MIN	MAX	MIN	MAX
A	---	0.0393	---	1.0000
A1	0.0000	0.0039	0.0000	0.1000
A2	0.0314	0.0354	0.8000	0.9000
b	0.0098	0.0157	0.2500	0.4000
c	0.0031	0.0059	0.0800	0.1500
D	0.0472	0.0551	1.2000	1.4000
E	0.0629	0.0709	1.6000	1.8000
E1	0.0984	0.1063	2.5000	2.7000
L	0.0187TYP		0.475TYP	
L1	0.0098	0.0157	0.250	0.400
e	0°	8°	0°	8°

■Soldering Footprint

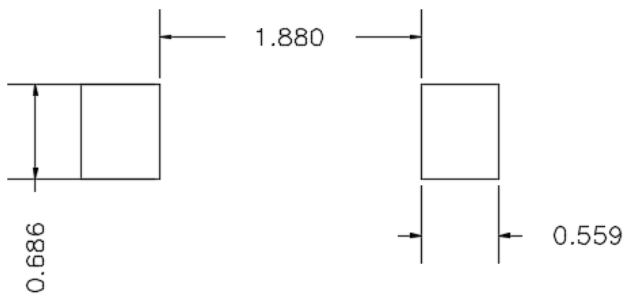

UNIT : mm

SUGGESTED SOLDER PAD LAYOUT



BZT52B2V4S THRU BZT52B75S

Disclaimer

The information presented in this document is for reference only. Yangzhou Yangjie Electronic Technology Co., Ltd. reserves the right to make changes without notice for the specification of the products displayed herein to improve reliability, function or design or otherwise.

The product listed herein is designed to be used with ordinary electronic equipment or devices, and not designed to be used with equipment or devices which require high level of reliability and the malfunction of which would directly endanger human life (such as medical instruments, transportation equipment, aerospace machinery, nuclear-reactor controllers, fuel controllers and other safety devices), Yangjie or anyone on its behalf, assumes no responsibility or liability for any damages resulting from such improper use of sale.

This publication supersedes & replaces all information previously supplied. For additional information, please visit our website [http:// www.21yangjie.com](http://www.21yangjie.com) , or consult your nearest Yangjie's sales office for further assistance.