

DP2.5-3L

DIN

>

:2021-09-08

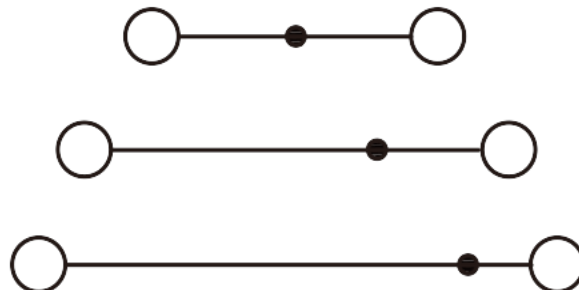
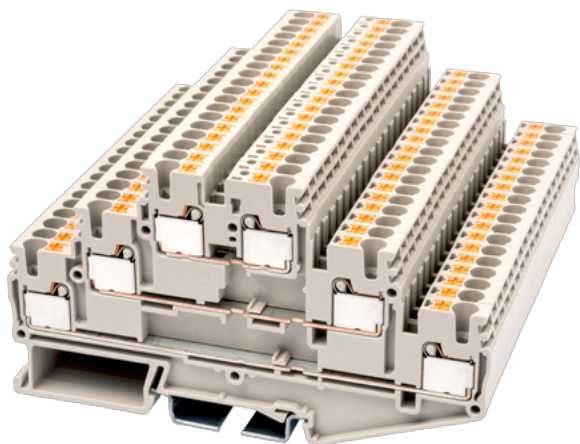

300V, 20A, Beige (default)

	Three level Feed-Through Terminal Block, Push-in Design
	Three level Feed-Through Terminal Block
	Beige (default)
	Push-in Design
	Rail Mounting
(mm)	102.7
(mm)	5.1
(mm)	57
()	1P
	Three level
	6
	PA
	I
UL 94	V0
	500M at DC 500V

-IEC

(V)	500
(A)	24
(III/3)(V)	500
(III/3)(KV)	6
(mm ²)	0.14
(mm ²)	4
(mm ²)	0.14
(mm ²)	2.5
(mm ²) , ,	0.25
(mm ²) , ,	2.5
(mm ²) , ,	0.25
(mm ²) , ,	2.5
² (mm ²) , ,	0.5
Width)(mm) (Blade thickness x	0.6x3.5
	10
	TS-35
	YES
	NO

-UL

(UL/CUL Group B)(V)	300
(UL/CUL Group B)(A)	20
(UL/CUL Group C)(V)	300
(UL/CUL Group C)(A)	20
UL/CUL AWG	26
UL/CUL AWG	12
UL/CUL AWG	26
UL/CUL AWG	12

&

--	--



가 (YES or NO)	YES
	120
	-40

UL

(Group B)(AWG)	26~12
(Group B)(V)	300
(Group B)(A)	20
(Group C)(AWG)	26~12
(Group C)(V)	300
(Group C)(A)	20

CUL





(Group B)(AWG)	26~12
(Group B)(V)	300
(Group B)(A)	20
(Group C)(AWG)	26~12
(Group C)(V)	300
(Group C)(A)	20

VDE

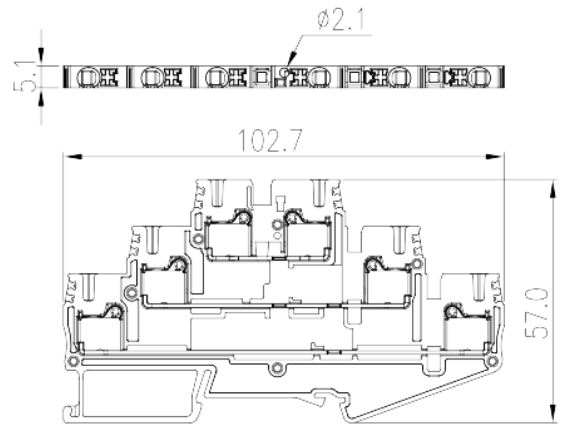
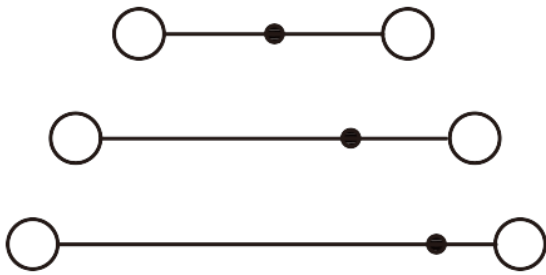
(mm ²)	0.14~2.5
(V)	500
(A)	24

--	--

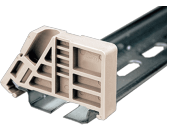

	<p>TS-35C DIN rail end cap For TS-35 rail. Black color. Using UL94-V2 class of insulation material.</p>
	<p>TS-35 DIN-Rail For DP / DP-PE / DK / DK-PE / AK / AK-PE / AK..P series. Material is iron. Length of 1000mm / 2000mm.</p>
	<p>SS11 End Bracket For TS-35, TS-35/15 rails. Grey color. Using UL94-V0 class of insulation material.</p>
	<p>DSD01-2.5XXN Plug-in bridge</p>

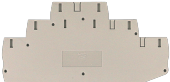
	<p>color. Using UL94-V0 class of insulation material. For DP2.5/AK2.5/AK2.5-TN/AK2.5-TR/AKK2.5/AK2.5-TP/AK2.5-TN-TP/AK2.5-TR-TP/AK2.5-TG/AK2.5-TN-TG/AK2.5-TR-TG/AK2.5-CP/AK2.5-TN-CP/AK2.5-TR-CP/AKK2.5-D01/AKK2.5-D02/AKK2.5-D03/AKK2.5-D04 Red Marking Label For BEST APPLICATION : DP2.5, DP2.5-TN, DP2.5-TR, DPP2.5, DP2.5-3L, DP2.5-3L-PV, DP2.5-PE, DP2.5-TN-PE, DP2.5-TR-PE, DPP2.5-PE, DP2.5-3L-L3PE, DK2.5S, PM2.5WN, PMM2.5WN AVAILABLE APPLICATION : DP2.5-ES, DP2.5/1P, DP2.5PG-XXP, DKES1.5, DKES1.5-XXP, DKES1.5M-XXP White color. Using UL94-V2 class of insulation material.</p>
	<p>DP2.5C-3L End Cover For DP2.5-3L / DP2.5-3L-PV Grey color. Using UL94-V0 class of insulation material.</p>