

DP2.5-TR-PE

DIN

>

:2021-09-08

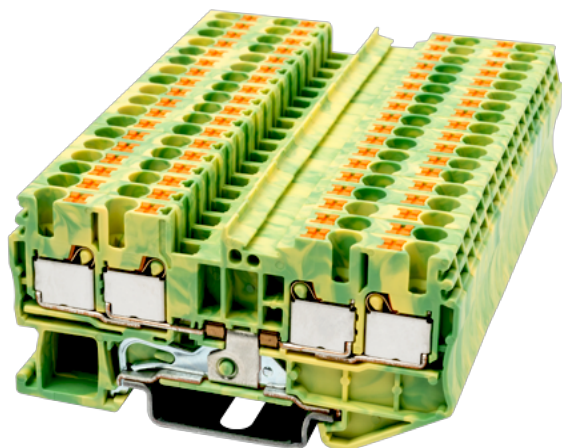

600V, Green-Yellow (default)

	Grounding Terminal Block, Push-in Design
	Grounding Terminal Blocks
	Green-Yellow (default)
	Push-in Design
	Rail mounting
(mm)	72.59999999999999
(mm)	5.1
(mm)	35
()	1P
	Single level
	4
	PA
	I
UL 94	V0
	500M at DC 500V

-IEC

(V)	800
(III/3)(V)	800
(III/3)(KV)	8
(mm ²)	0.14
(mm ²)	4
(mm ²)	0.14
(mm ²)	2.5
(mm ²) , ,	0.25
(mm ²) , ,	2.5
(mm ²) , ,	0.25
(mm ²) , ,	2.5
² (mm ²) , ,	0.5
Width)(mm) (Blade thickness x	0.6x3.5
	10
	TS-35
	YES
	YES

-UL

(UL/CUL Group B)(V)	600
(UL/CUL Group C)(V)	600
UL/CUL AWG	26
UL/CUL AWG	12
UL/CUL AWG	26
UL/CUL AWG	12

&

(YES or NO)	YES
가 (YES or NO)	YES
	120

-40

UL

(Group B) (AWG)	26~12
(Group B) (V)	600
(Group C) (AWG)	26~12
(Group C) (V)	600





CUL

(Group B) (AWG)	26~12
(Group B) (V)	600
(Group C) (AWG)	26~12
(Group C) (V)	600

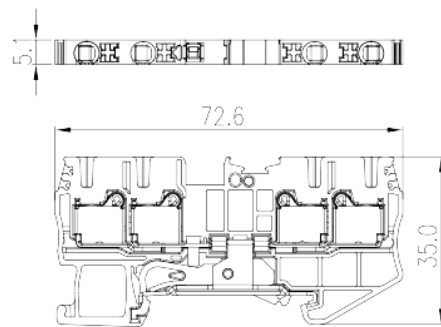
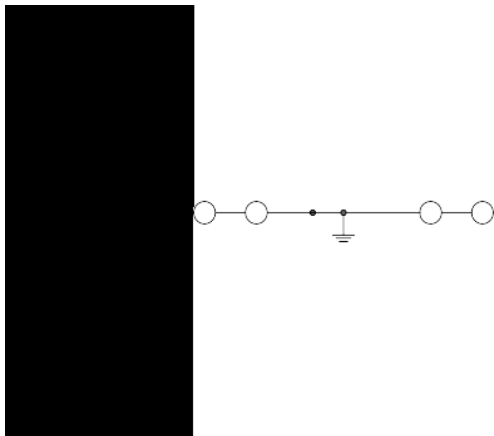
VDE

(mm ²)	0.14~2.5
(V)	800

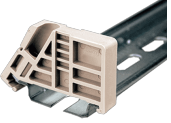

	<p>TS-35C DIN rail end cap For TS-35 rail. Black color. Using UL94-V2 class of insulation material.</p>
	<p>AKSPS-004 Partition Plate For AK1.5-TR/AK2.5-TR/AK2.5-TP/AK2.5-TN-TP/AK2.5-TN-TG. Grey color. Using UL94-V0 class of insulation material.</p>
	<p>TS-35 DIN-Rail For DP / DP-PE / DK / DK-PE / AK / AK-PE / AK..P series. Material is iron. Length of 1000mm / 2000mm.</p>
	<p>SS11 End Bracket For TS-35, TS-35/15 rails. Grey color. Using UL94-V0 class of insulation material.</p>
	<p>DSD01-2.5XXN Plug-in bridge For DP2.5/AK2.5/AK2.5-TN/AK2.5-TR/AKK2.5/AK2.5-TP/AK2.5-TN-TP/AK2.5-TR-TP/AK2.5-TG/AK2.5-TN-TG/AK2.5-TR-TG/AK2.5-CP/AK2.5-TN-CP/AK2.5-TR-CP/AKK2.5-D01/AKK2.5-D02/AKK2.5-D03/AKK2.5-D04 Red color. Using UL94-V0 class of insulation material.</p>
	<p>TM42W Marking Label For BEST APPLICATION : DP2.5, DP2.5-TN, DP2.5-TR, DPP2.5, DP2.5-3L, DP2.5-3L-PV, DP2.5-PE, DP2.5-TN-PE, DP2.5-TR-PE, DPP2.5-PE, DP2.5-3L-L3PE, DK2.5S, PM2.5WN, PMM2.5WN AVAILABLE APPLICATION : DP2.5-ES, DP2.5/1P, DP2.5PG-XXP, DKES1.5, DKES1.5-XXP, DKES1.5M-XXP White color. Using UL94-V2 class of insulation material.</p>
	<p>TM47W</p>



Marking Label

For BEST APPLICATION : DP2.5, DP2.5-TN, DP2.5-TR, DP2.5-PE, DP2.5-TN-PE, DP2.5-TR-PE, DP2.5/1P, DK2.5N, DK2.5N-TN, DK2.5N-TR, DKK2.5N, DKK2.5N-PV, DK2.5N-PE, DK2.5N-TN-PE, DK2.5N-TR-PE, DK2.5N-TP, DK2.5N-TG, DK2.5N-CP, DKK2.5N-TP, DKK2.5N-TG, DKK2.5N-CP, PM2.5N AVAILABLE APPLICATION : DK2.5-PE, DKES1.5, DKES1.5-XXP, DKES1.5M-XXP White color. Using UL94-V2 class of insulation material.